

# CONVEYOR SYSTEMS FOR BOXES

[www.mecalux.com](http://www.mecalux.com)







Logistics operations require a continuous flow of materials, as pallets and/or boxes must be taken from a storage or production position or from an overflow warehouse to shipment or production areas.

This transport can be done manually if the loads are lightweight, or by employing support equipment for heavy loads (forklifts, pallet trucks, stackers, etc.) that require human operation. When these movements are repetitive and consume resources that make their handling expensive, the support of automated elements is necessary, such as conveyors for example.

Conveyors are static transport devices that have a series of rollers, chains and belts. Electric-powered motors move the pallets or boxes in a regulated and continuous manner.

In the logistics sector, storage solutions that reduce material handling and minimise labour costs are becoming increasingly more important. Such systems reduce

accidents, mistakes and final handling costs.

These transport systems are applicable to all sizes of warehouses, not only the large automated warehouses in which they provide the ideal connection between the stacker cranes and the entry, dispatch and handling of the load units. The advantage rests in the fact that by using a conveyor system, a constant flow of products can be achieved and many different combinations can be executed, something which is practically impossible with manual systems as other factors come into play, such as human intervention.

Recently, the standardisation of this product has led to a drop in its price, which makes its installation more affordable in any warehouse or factory where different work stations need to be connected.

This catalogue describes all items that are part of the transport chain, from the most visible parts, such

as the mechanics and electricity, to those which cannot be seen but are equally important such as the control of all the different components.

All the solutions set forth in this catalogue are part of real solutions that have been applied and are used as the basis for our examples. However, each warehouse will have a specific custom solution, which must be carefully studied for each case.

Thanks to more than 50 years working in partial and complete warehousing solutions, Mecalux's Technical Department has extensive logistics experience, and our specialist are happy to share this knowledge with customers in order to optimise their installations.

The catalogue is divided into three parts:

- Conveyors for pallets
- Conveyors for boxes
- Operations logic

# CONVEYORS FOR BOXES

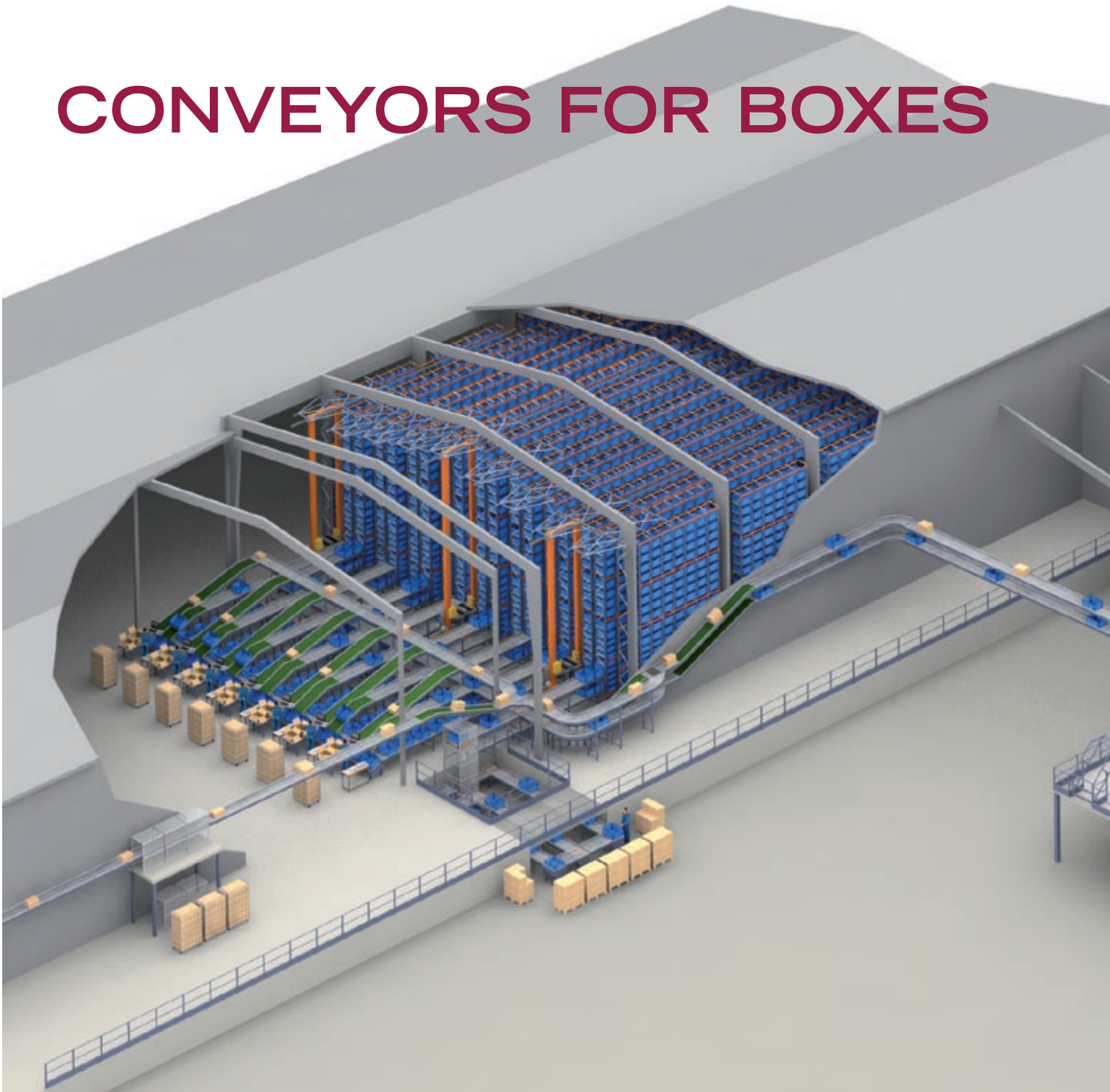

Automated transport of boxes follows very similar criteria to those for pallets and is developed to work with plastic and cardboard boxes. The most common transport module is the roller conveyor, in all its different variations –straight, curved, diversion and injection modules, etc.- complemented by band and belt conveyors, as well as lifts and inclined conveyors to overcome changes in height.





## SUMMARY

### AUTOMATED TRANSPORT SYSTEM FOR BOXES

#### General Characteristics

- > Reception and distribution of goods
- > Head ends and picking posts in automated warehouses
- > Optimised order preparation areas
- > Automatic order sorting
- > Assembly and verification posts

#### Conveyor Components

- > No-pressure roller accumulator conveyor
- > Curved roller accumulation conveyor
- > Continuous activated roller conveyor
- > Free roller conveyor
- > Continuous belt conveyor
- > Roller conveyor with delay lifting
- > Mixed transfer roller & belt conveyor
- > Launcher roller conveyor
- > Bridge belt conveyor
- > Booster conveyor
- > Oblique box transfer
  - > Discontinuous lift
  - > Continuous lift
- > Periphery:
  - > Lateral picking station
  - > Front picking station

#### Safety in the Warehouse



## AUTOMATED TRANSPORT SYSTEM FOR BOXES

All transport circuits have at least one starting point and one destination point. The simplest circuit is comprised of a straight section of rollers or bands, as depicted in the two images below.

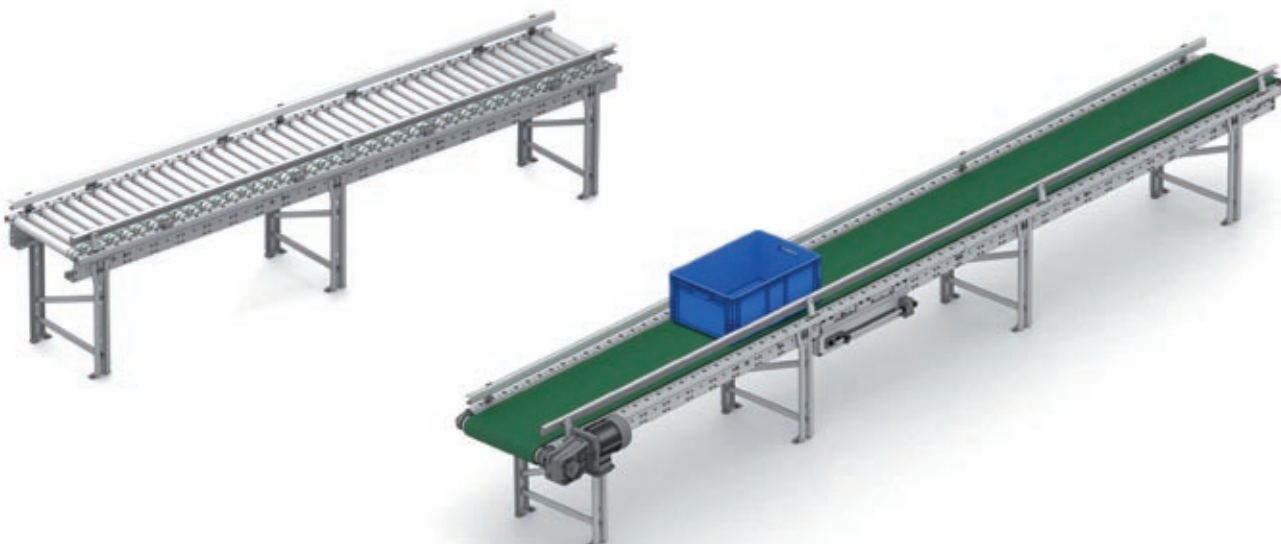



There are two systems that can be employed to form circuits with angles, either via curve modules or crossover modules, as depicted here.

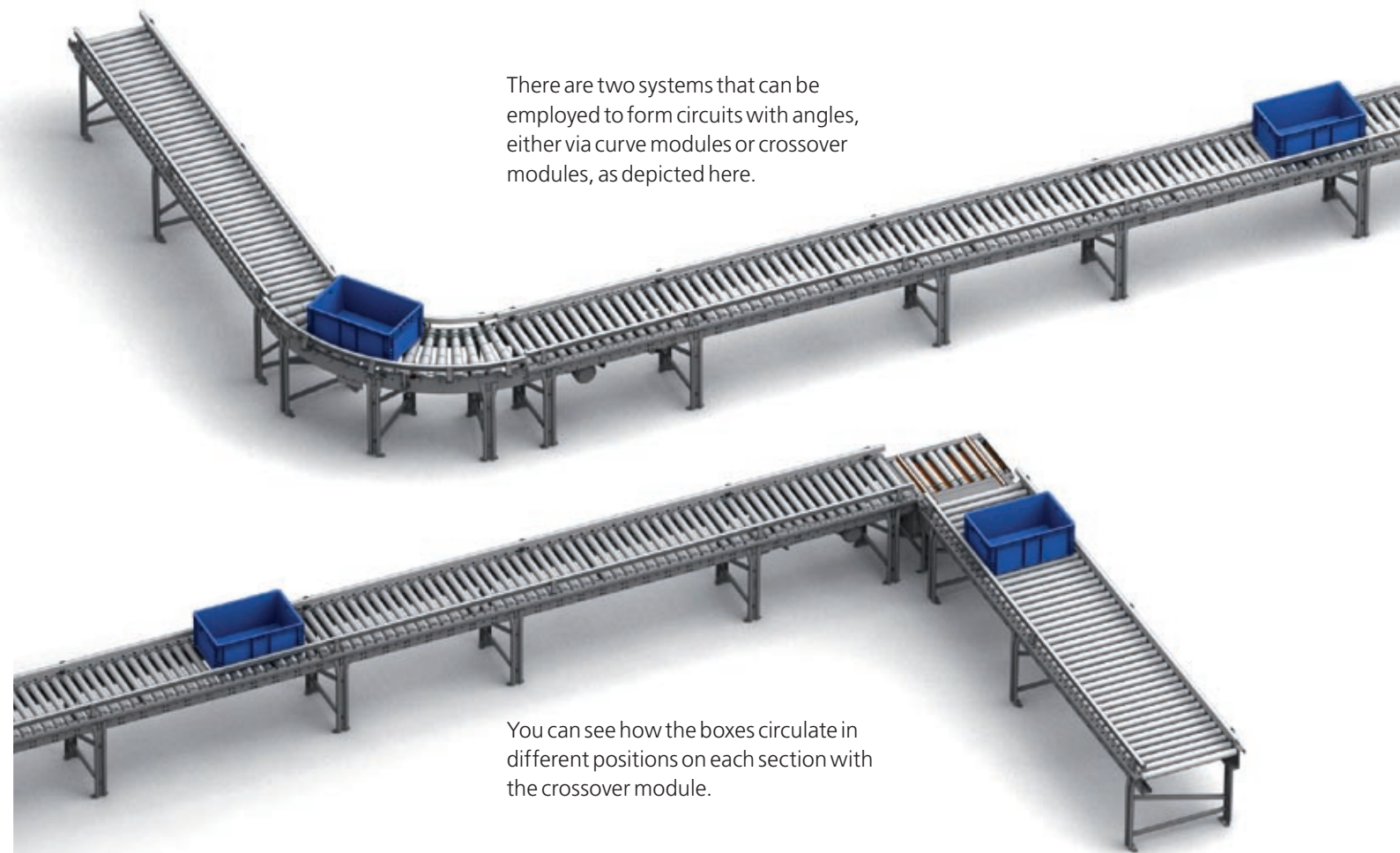

You can see how the boxes circulate in different positions on each section with the crossover module.

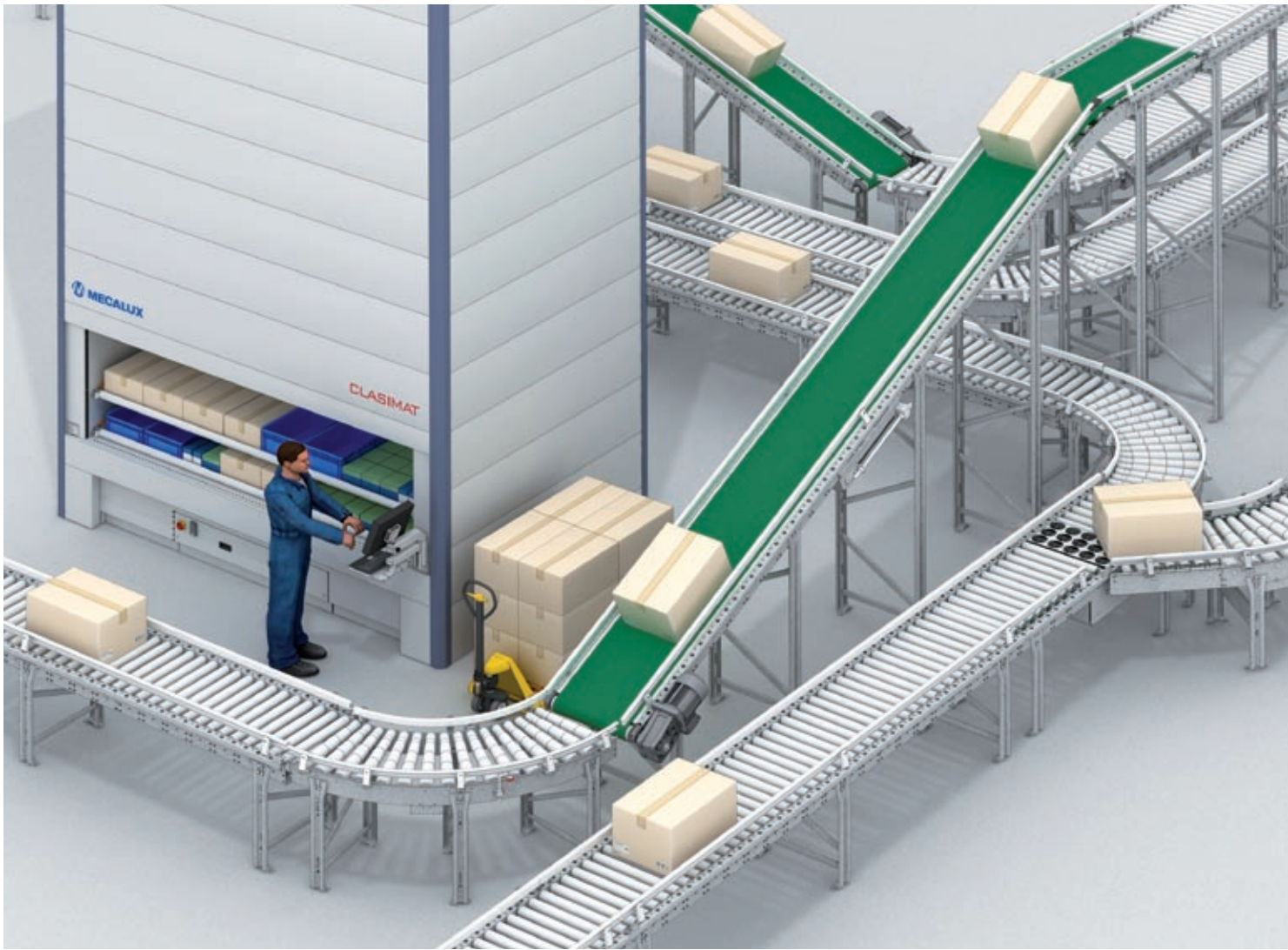

If circuits at different levels need to be connected, inclined band or lift conveyors must be employed.

From these basic components, an infinite number of circuits can be created, from the simplest to the most complex.





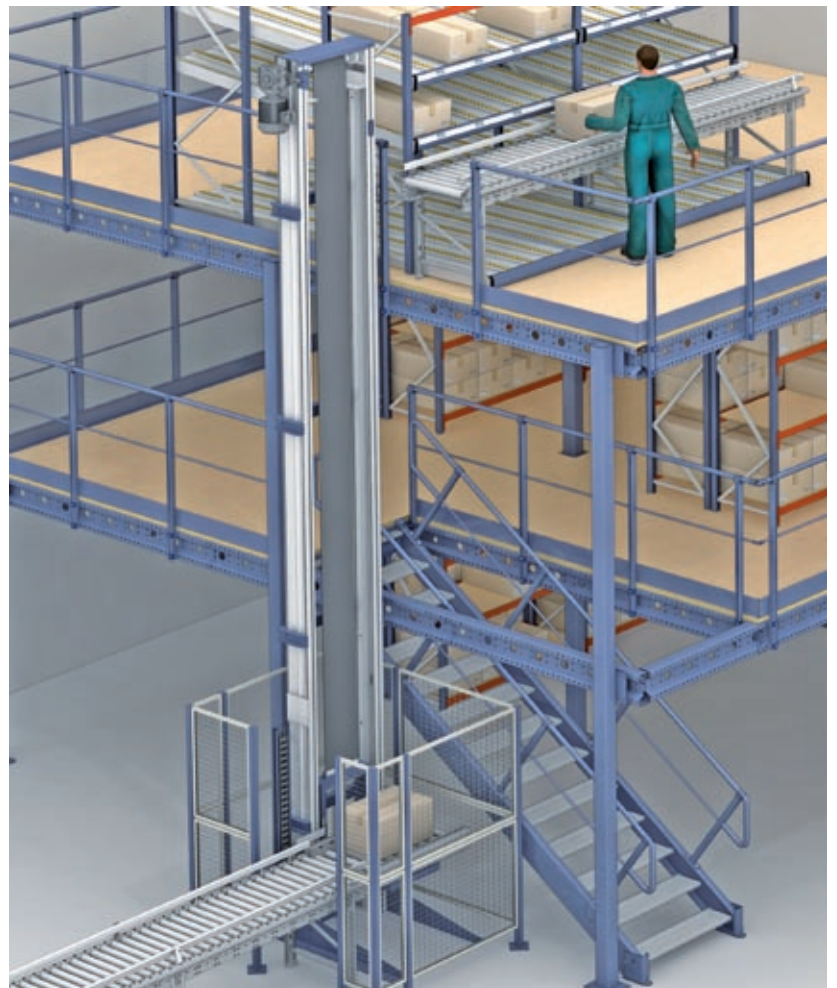
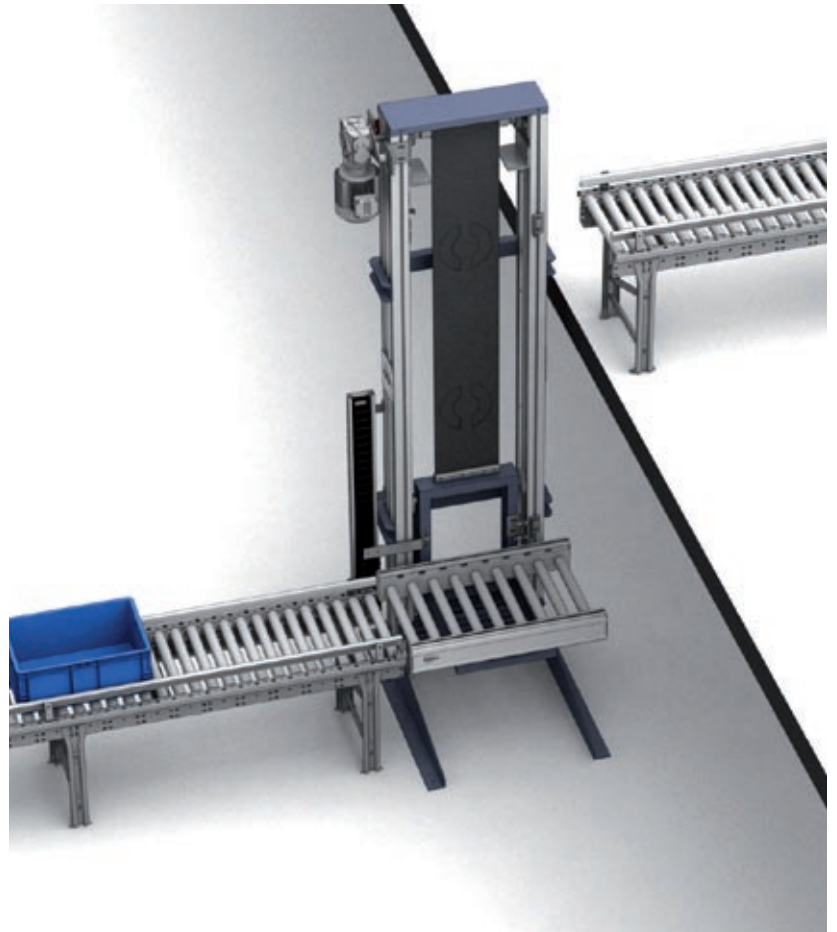

This is an example of a complex circuit showing various start and end points and demonstrating different operation methods and ways to connect each of the plants and working areas. You can also see the almost total absence of non-automated internal transport, with the consequent benefits that this can entail.

The different areas of this installation will be analysed hereafter in greater depth, as well as all the components.

1. Reception and distribution of goods
2. Head ends and picking posts in automated warehouses
3. Optimised order preparation areas
4. Automatic order sorting
5. Assembly and verification posts

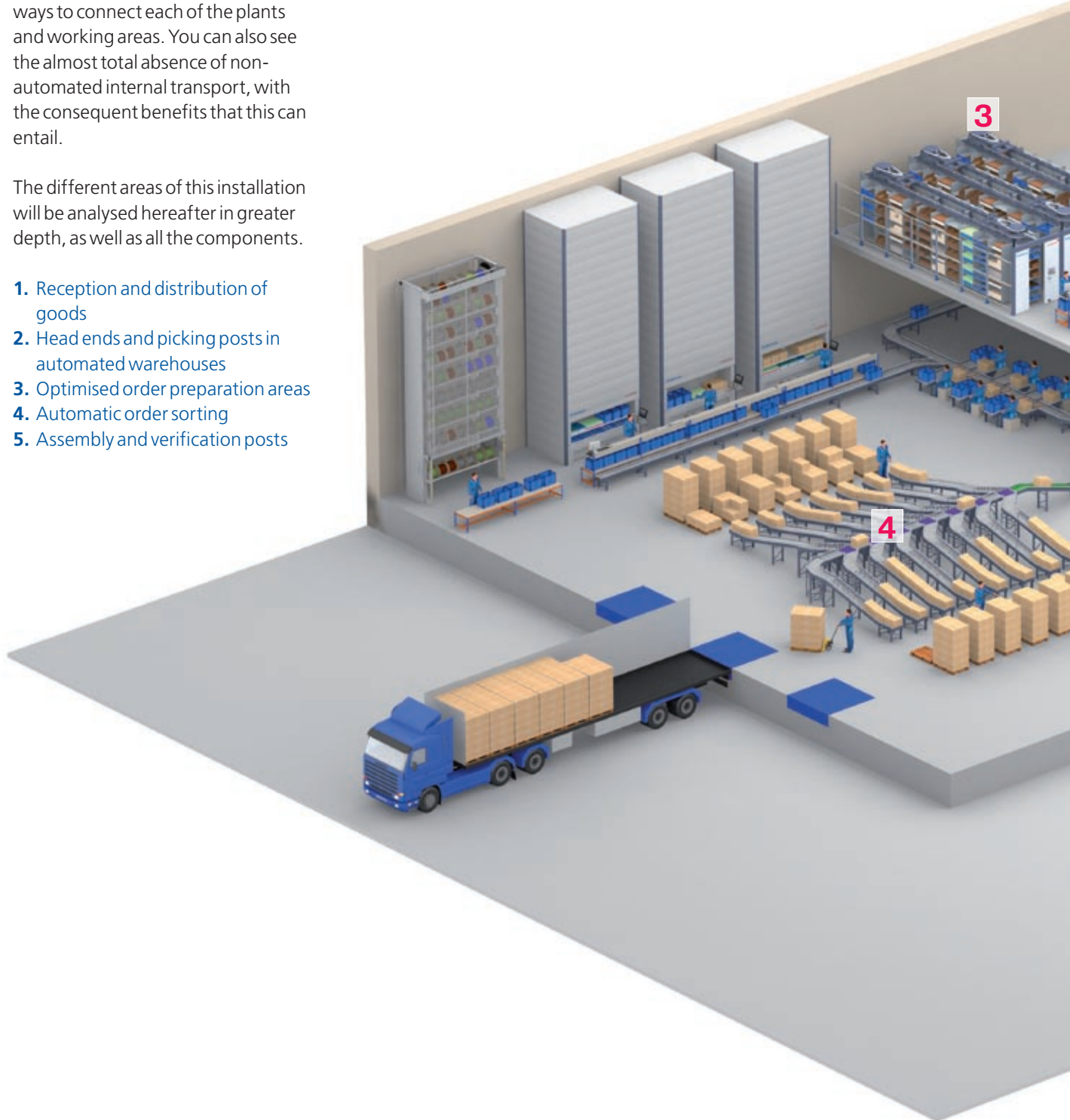

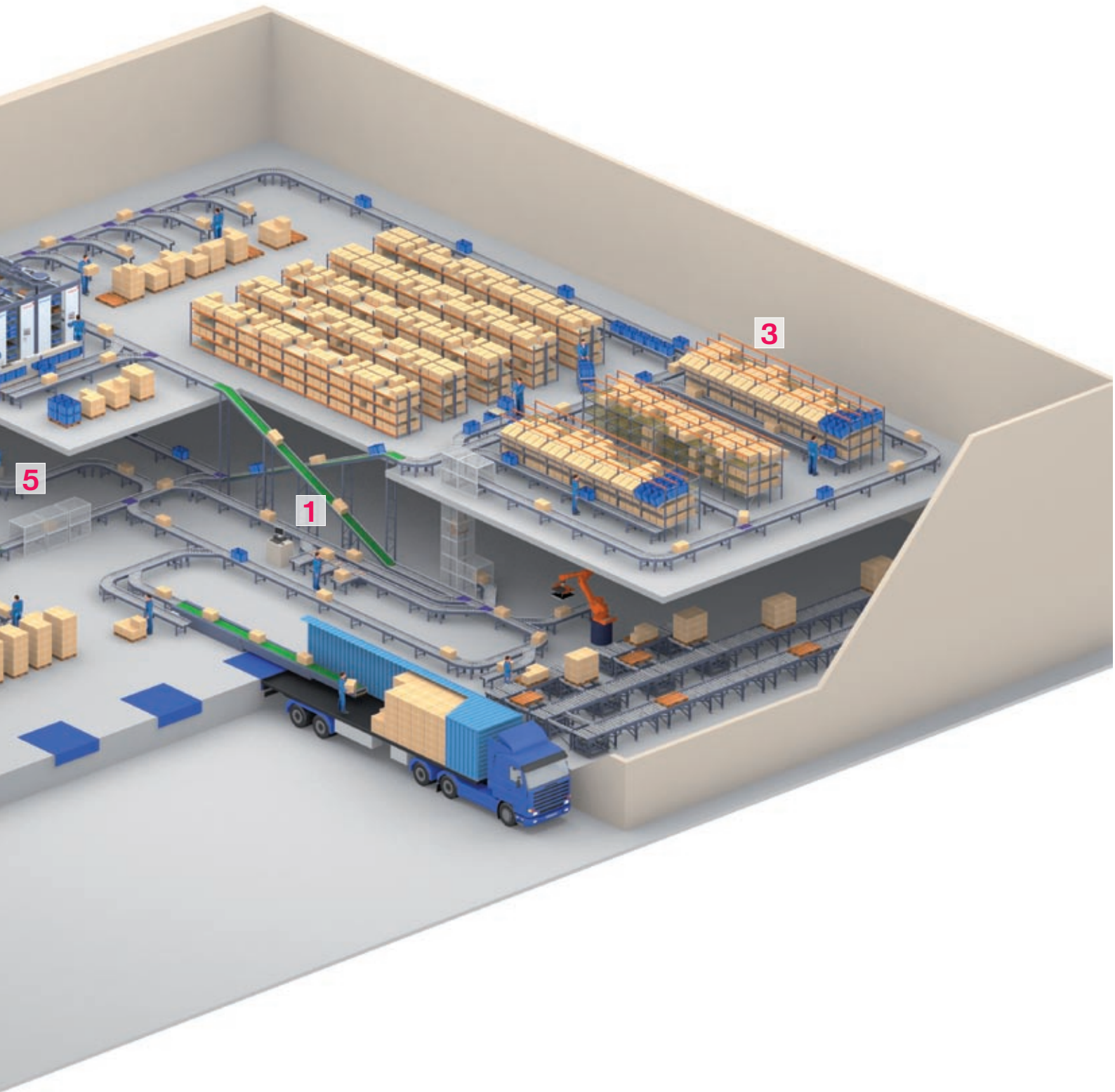

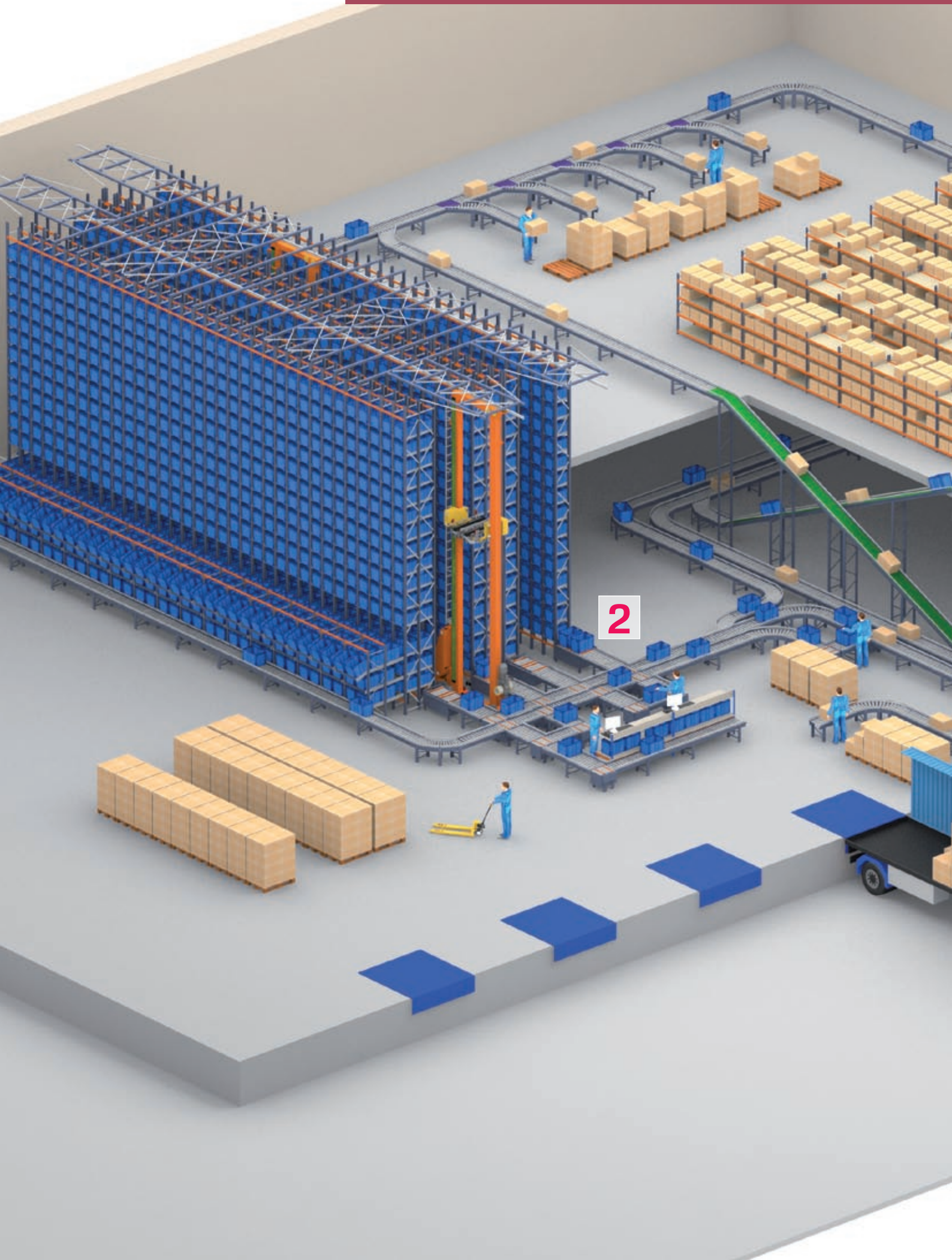

2

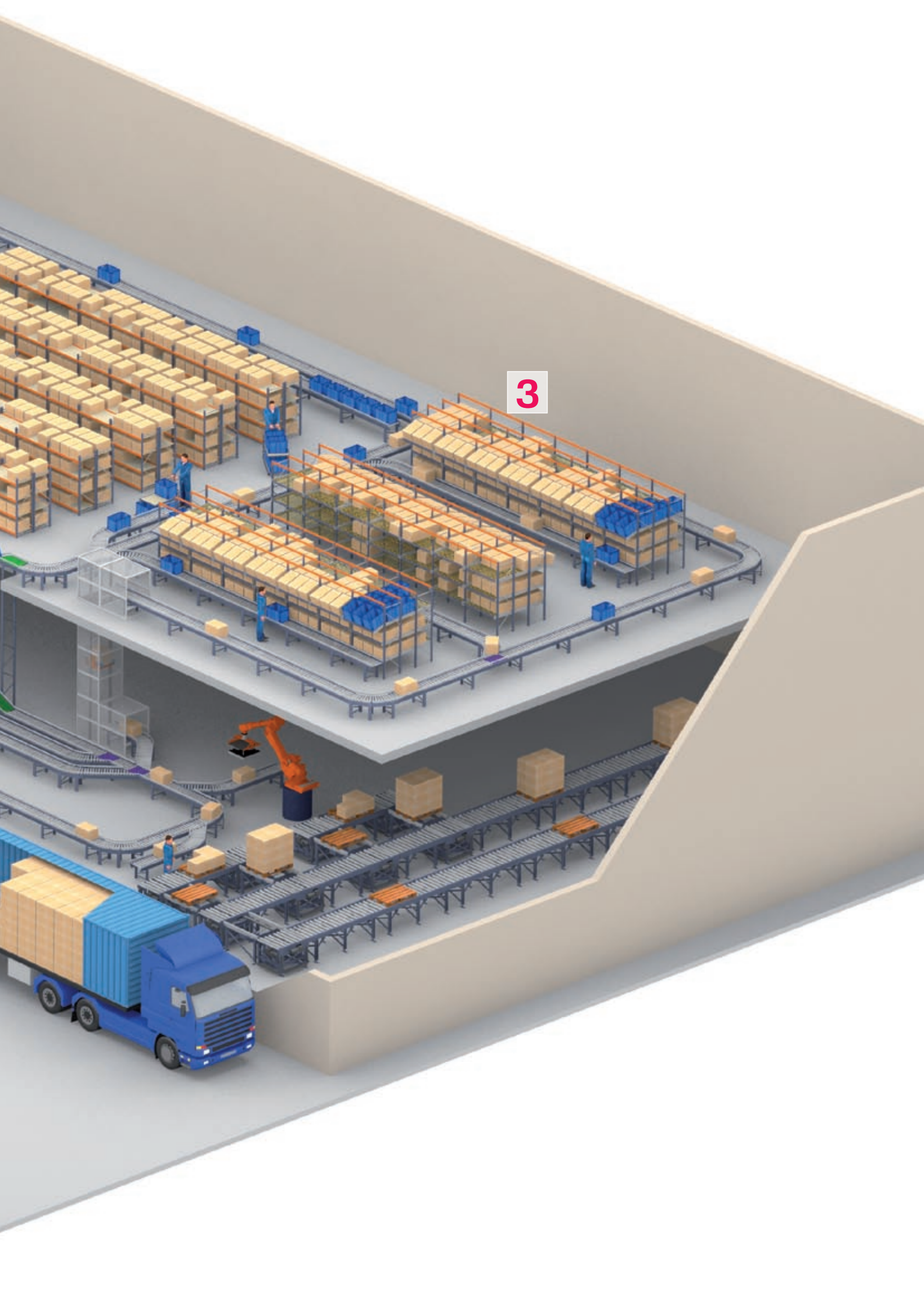

3

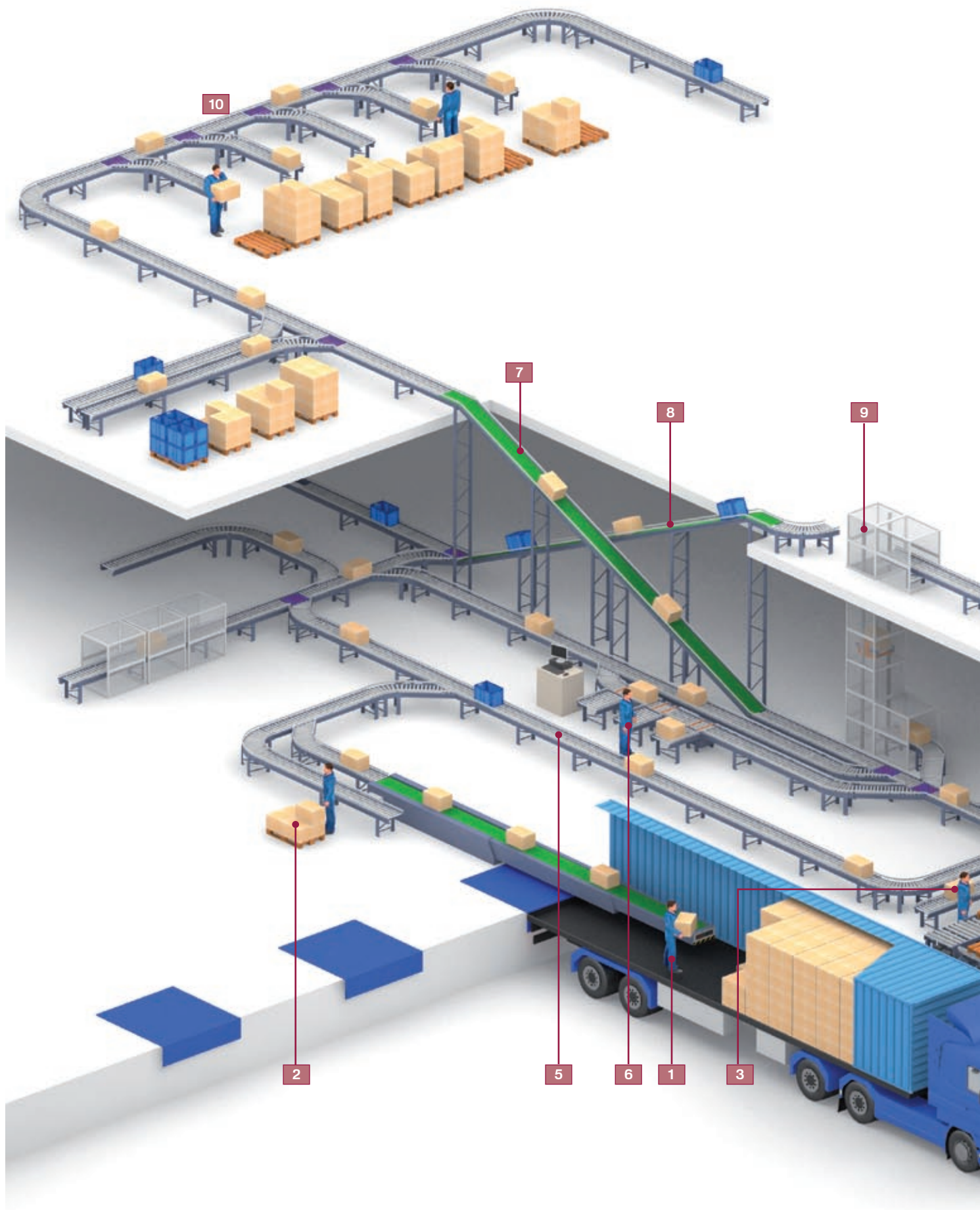

# 1

## RECEPTION AND DISTRIBUTION OF GOODS

With various conveyor components, the entire process of receiving goods in boxes and transporting them to different circuits can be controlled and executed completely automatically.

Placing the boxes onto the circuit can be done manually by an operator or automatically with a depalletising robot. In general, pallets come from outside, arriving on lorries and in containers and from the production lines or other warehouses on pallet conveyors.

When goods arrive in sea containers and are not palletised, an extendable band conveyor can be placed into the container itself to make handling easier.

Different reading and verification devices are strategically installed along the circuit, keeping all boxes under control at all times.

Reception can be done from one or more posts installed at the most appropriate points. Destinations can also be highly varied, therefore splitters and junction tables are employed, which divert the boxes to the most suitable conveyor. When different floors need to be connected or there are changes in altitude, you can choose between installing inclined band conveyors or lifts. The different types of lifts available depend on the required flow.

Goods can reach the unloading bays on lorries or in containers, with the boxes palletised or stacked on the floor without pallets. The way unloading is done will be different in the two cases.

### Basic Components

1. Unloading of sea container with goods not on pallets
2. Manual unloading of palletised goods stacked on floor
3. Manual unloading of palletised goods arriving on conveyors
4. Automated unloading with an anthropomorphic robot
5. General circuit
6. Quality control post
7. Belt conveyors at heights
8. Belt conveyors for lowering boxes
9. One-way lift
10. Sorting

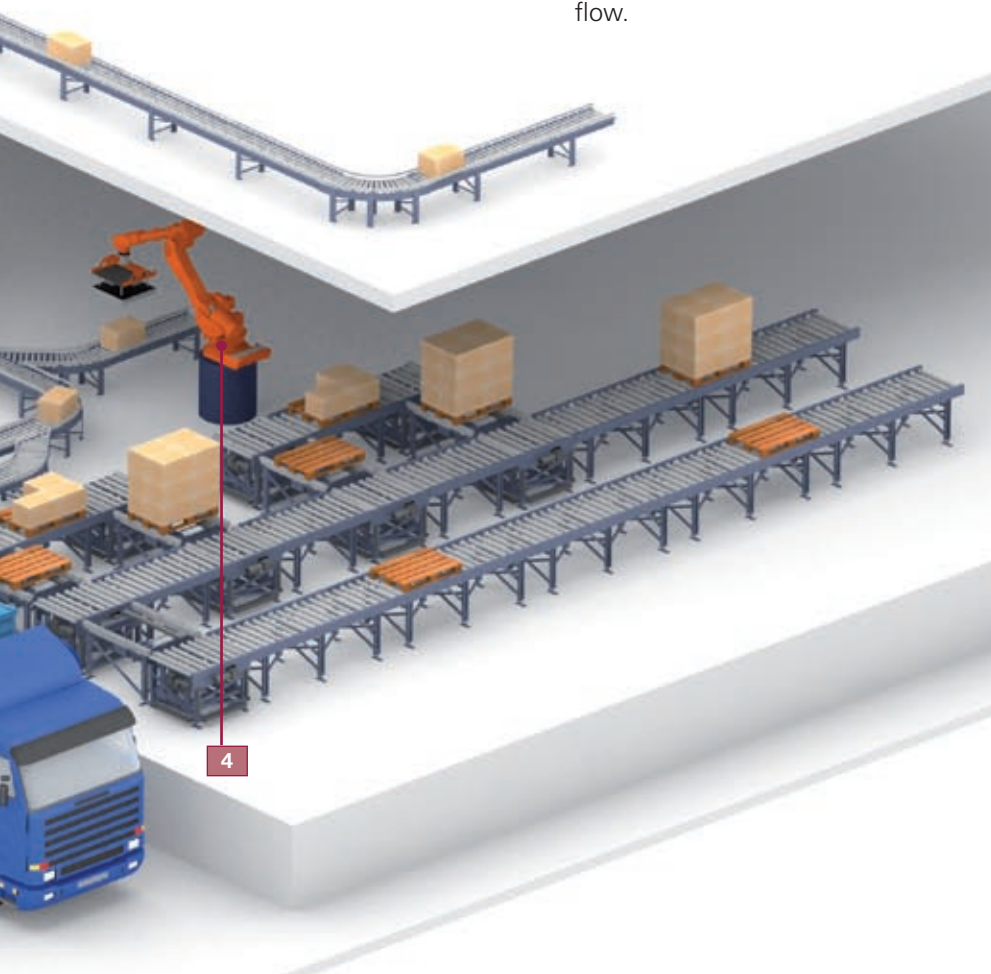

## 2

### HEAD ENDS AND PICKING POSTS IN AUTOMATED WAREHOUSES

Box conveyors are essential in all automated processes, and this is equally true in automated warehouses. These components are necessary at the head-ends, entry and exit points, picking and reprovisioning posts and, in many cases, for connections with the other parts of the production process.

The automated warehouse head-end can be extremely simple, but can also require an integrated circuit for the simultaneous circulation of a large quantity of boxes in high yield warehouses. The two illustrations below depict two scenarios: a simple one for installations with only one lane and another complex solution for a high-output warehouse.



Conveyors must also be installed for automated solutions in which head-end picking is combined with dynamic-channel picking, situated at the side and fed by stacker cranes, both free and automatic, in order to facilitate order preparation.

The image above shows an operator working in a picking corridor. There are dynamic channels on one side, fed by a stacker crane, and dynamic box and pallet channels on the other side, which are fed by conventional systems. Pick to light devices are used in both cases.

This solution employs a free conveyor, which is used as a preparation table, and an automatic conveyor for pre-prepared orders.

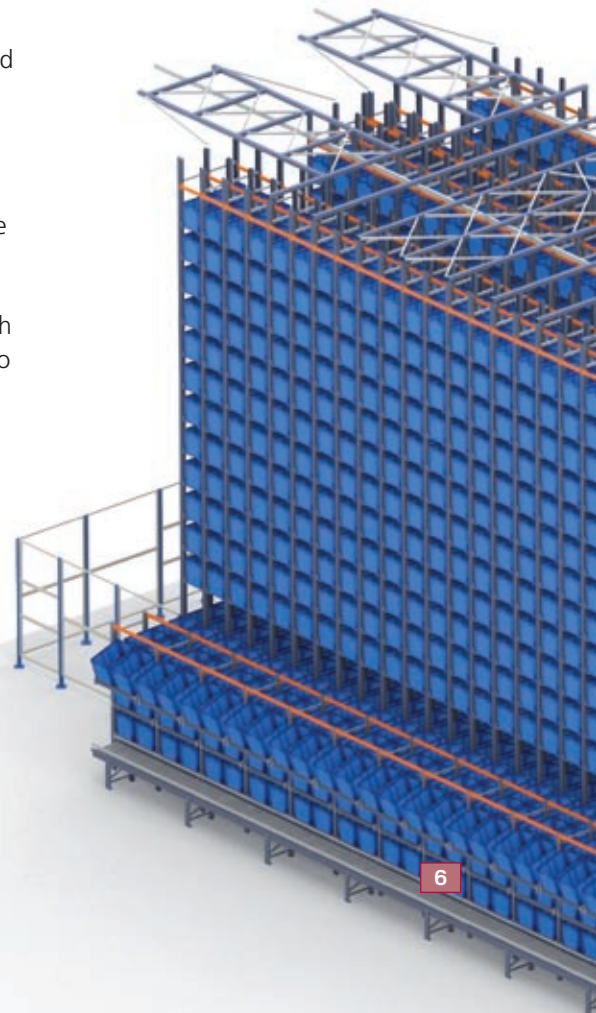
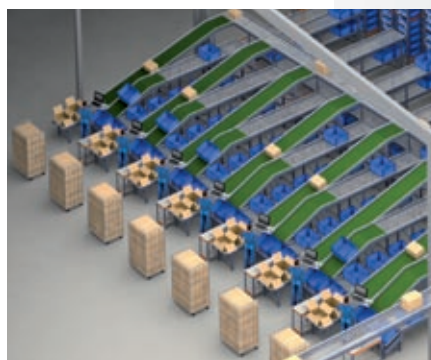
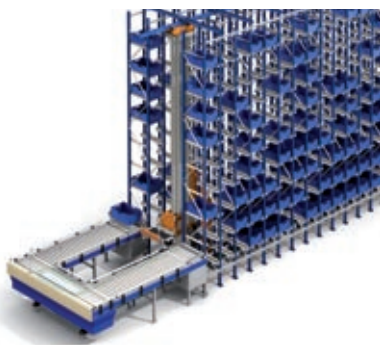



## Basic Components

1. General conveyor for entries from production or reception
2. Re provisioning post (goods replacement)
3. Exit conveyor and connection to other areas
4. Entry and exit racks to the warehousing lanes
5. U-shaped picking post
6. Side conveyor for preparing orders in dynamic channels
7. Prepared order conveyor behind multiple order tables

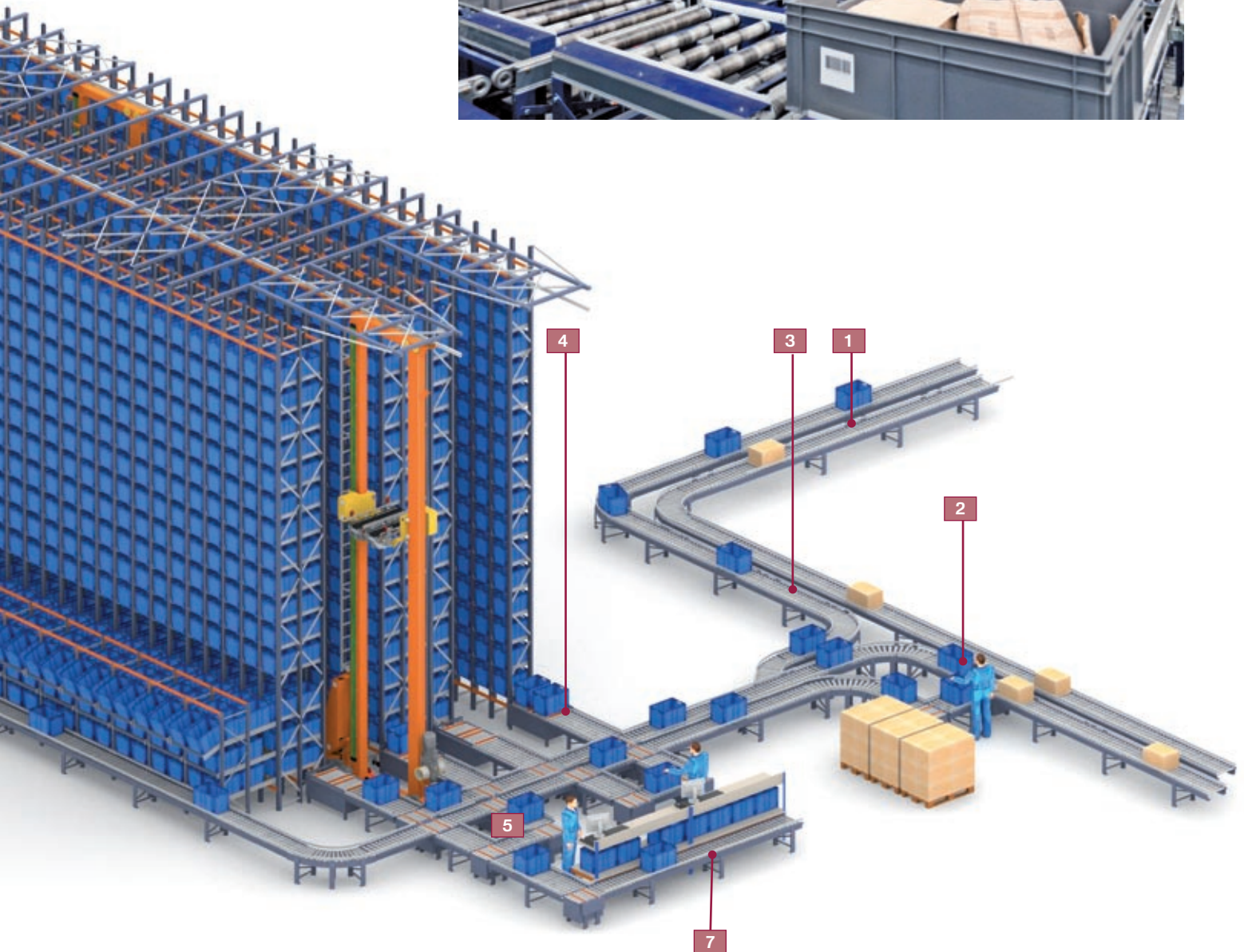

### 3

#### OPTIMISED ORDER PREPARATION AREAS

Installing conveyors in any warehousing and order preparation system is an ideal solution as it increases productivity. Advantages include:

- Eliminating or reducing the use of carts and double handling of goods.
- Operators remain in ergonomic positions, decreasing fatigue.
- Makes handling easier, limiting personnel's movements.
- Permits connection to other preparation, consolidation and dispatch areas.

In the example on the right, the conveyors service a conventional manual picking area and another picking area with dynamic shelves. In the first case, the injection posts for the transport circuit are located at one end of the corridors and preparation is done with carts. This solution avoids having manual transport to other areas. There are no carts in the picking area with dynamic shelving and the conveyors are located at the front of the shelves to facilitate all replacement and picking functions.

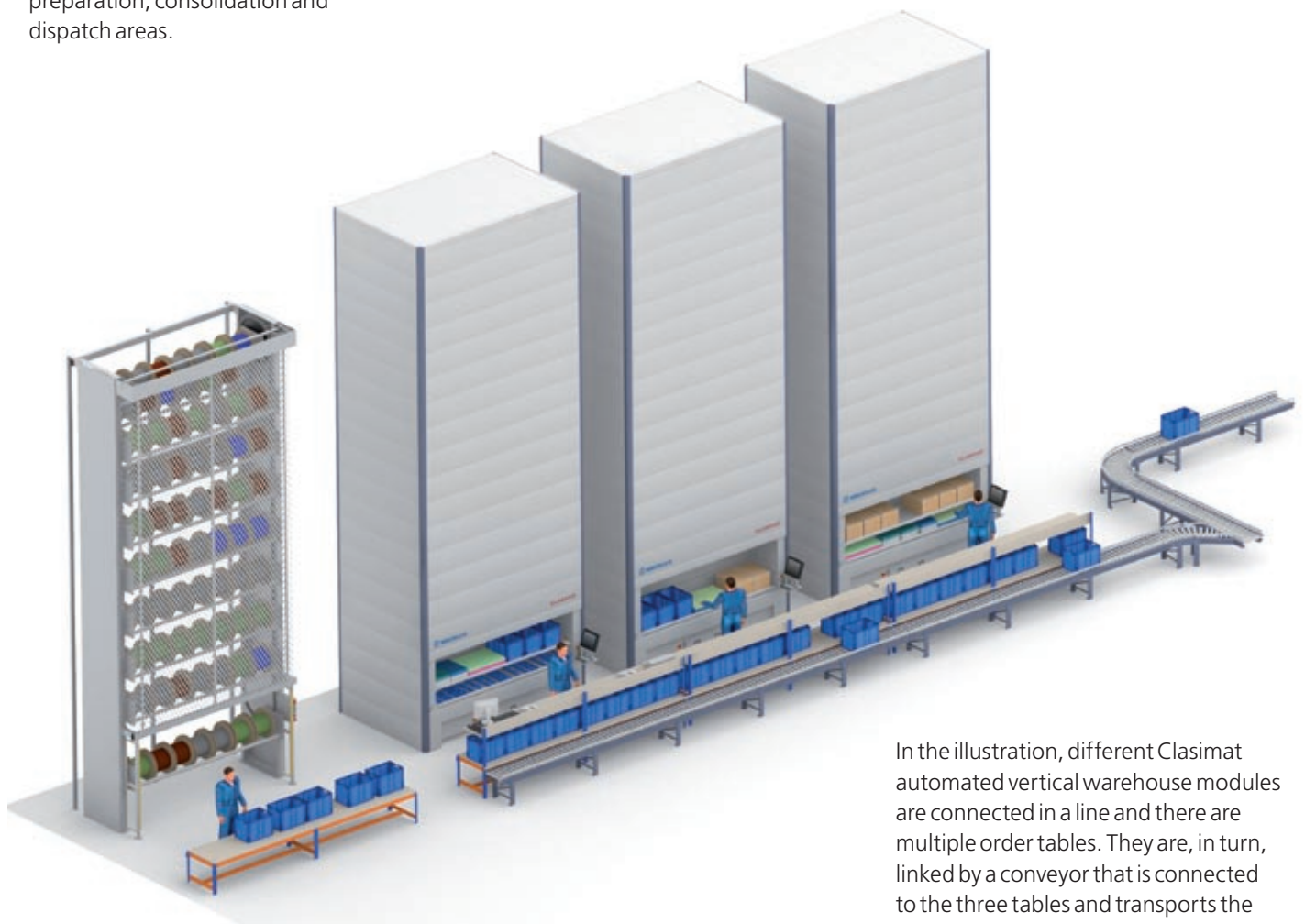
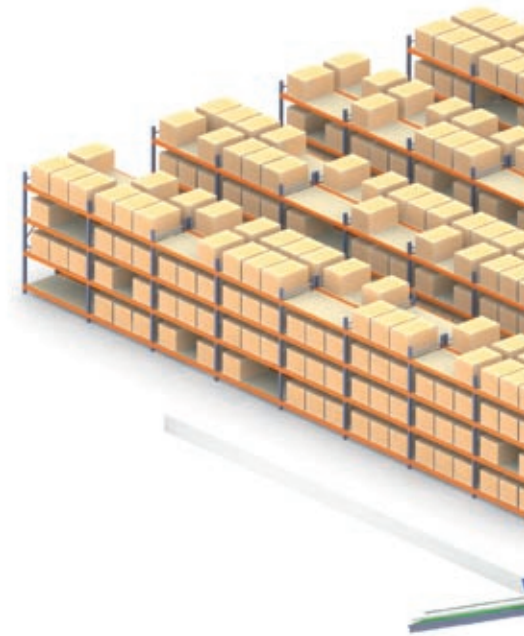

In the illustration, different Clasimat automated vertical warehouse modules are connected in a line and there are multiple order tables. They are, in turn, linked by a conveyor that is connected to the three tables and transports the prepared orders.

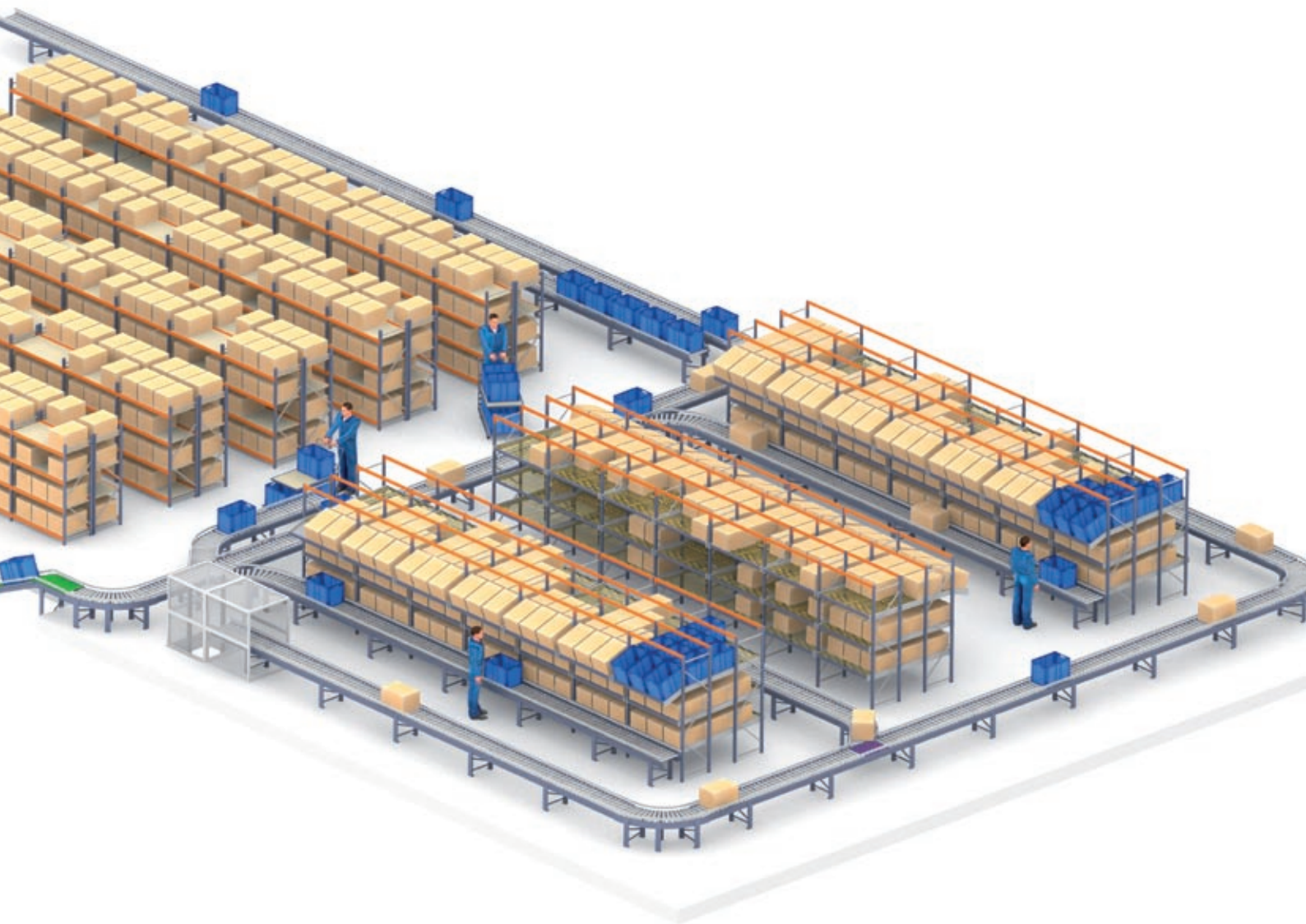

This image depicts an installation with three Spinblock horizontal carousels for high-yield picking with multiple order tables. One conveyor circulates the replacement goods and the other the prepared orders.

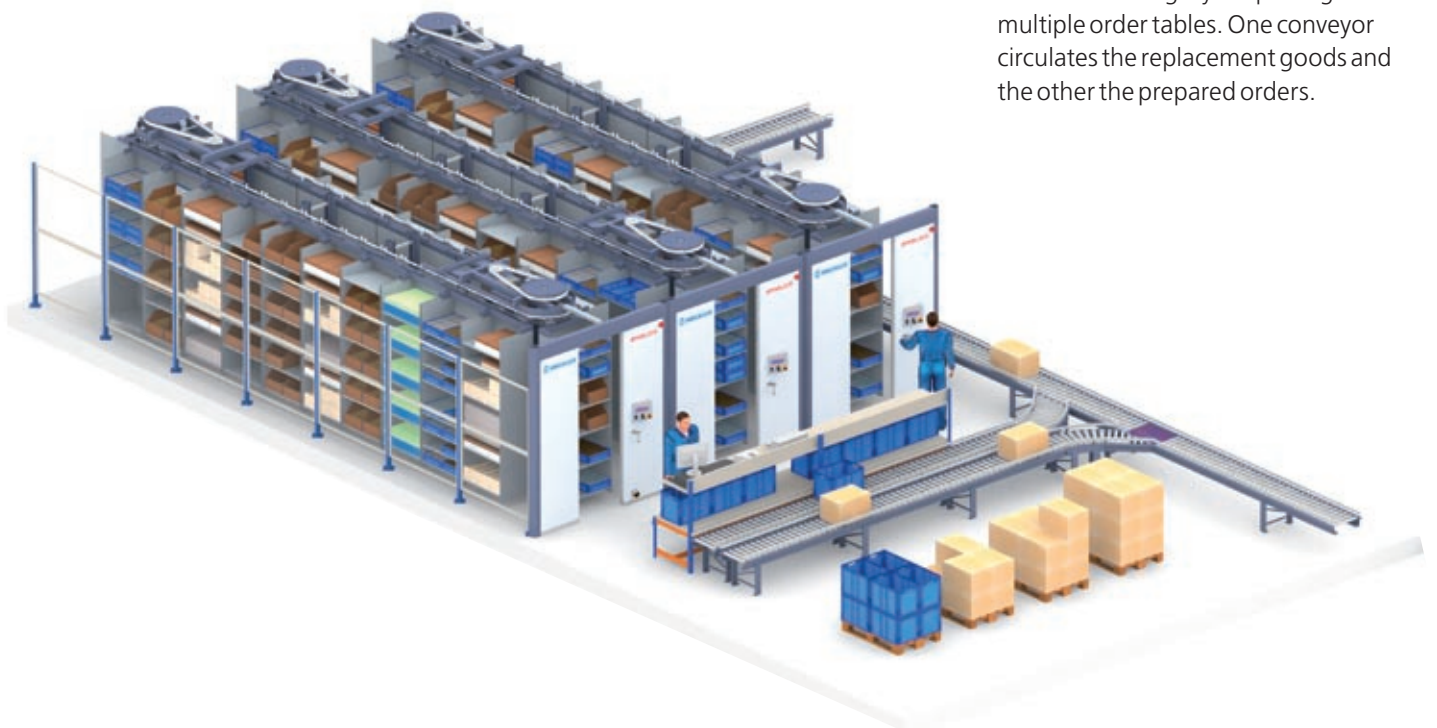

## 4

### AUTOMATIC ORDER SORTING

In an integrated warehouse, all goods that are prepared in the different areas must be sent to the dispatch area. This illustration depicts a goods sorter, classifying products according to either orders or routes. Using branching modules, this system is based on standard conveyors that distribute the boxes to the appropriate channels where they are accumulated and later –either manually or automatically– placed on the transport pallets to send to different clients.

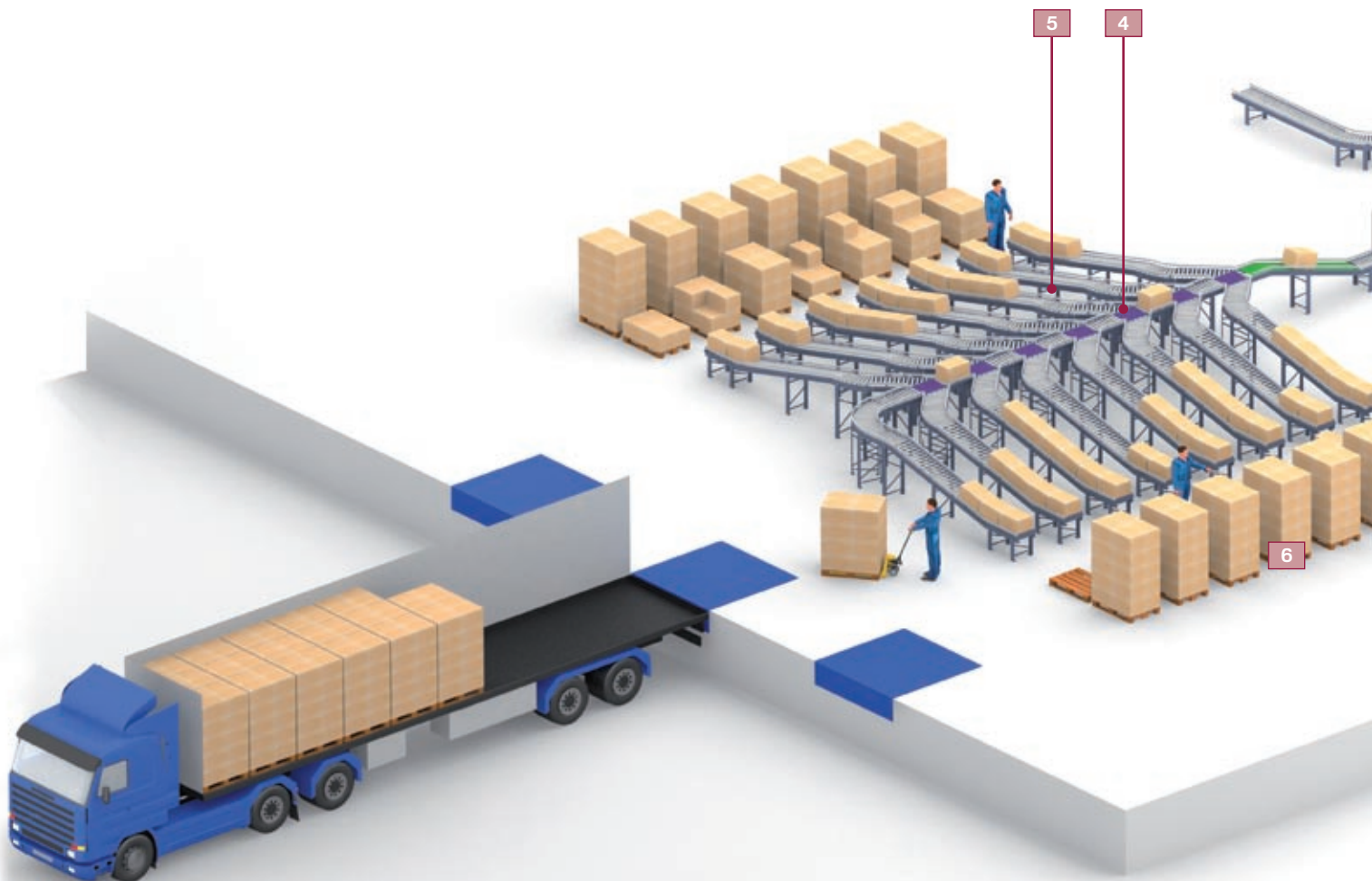
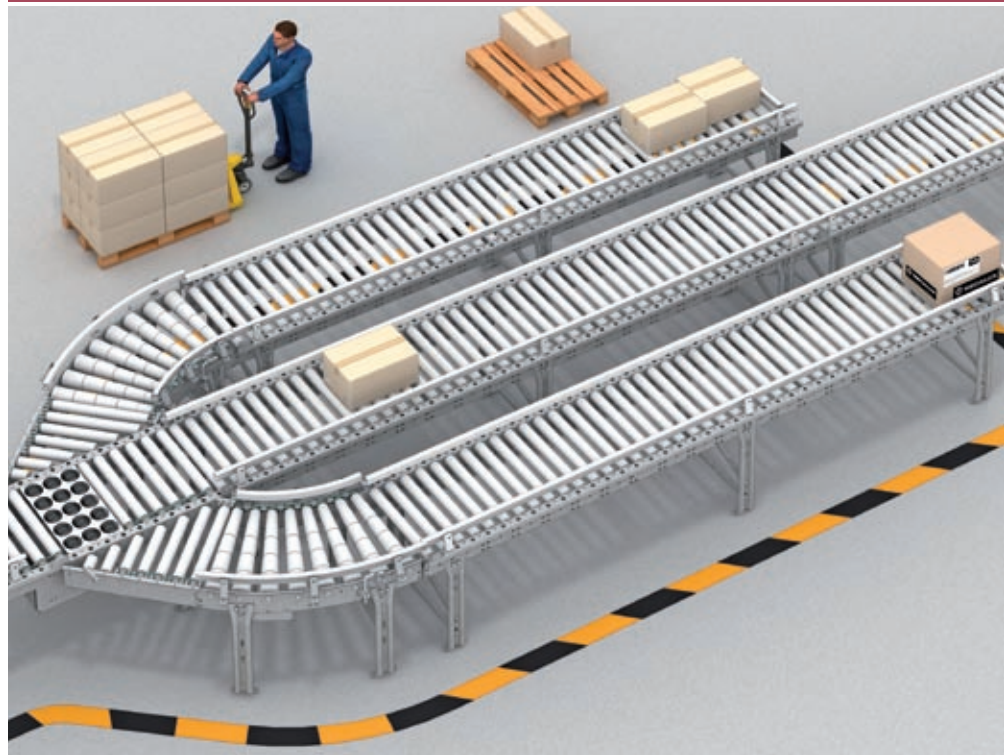

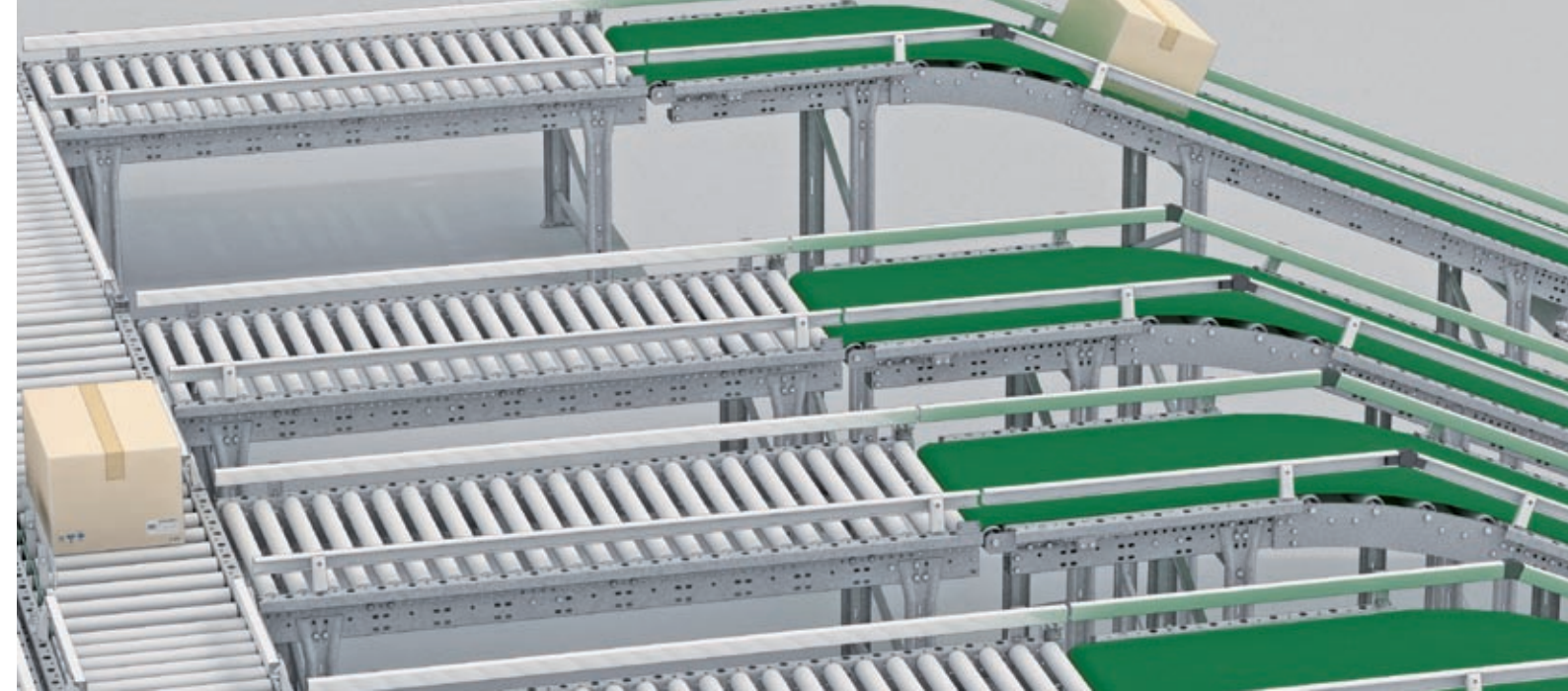

The boxes must have first been identified using barcode labels, which will be read at the decision points and directed to the sorting channels.

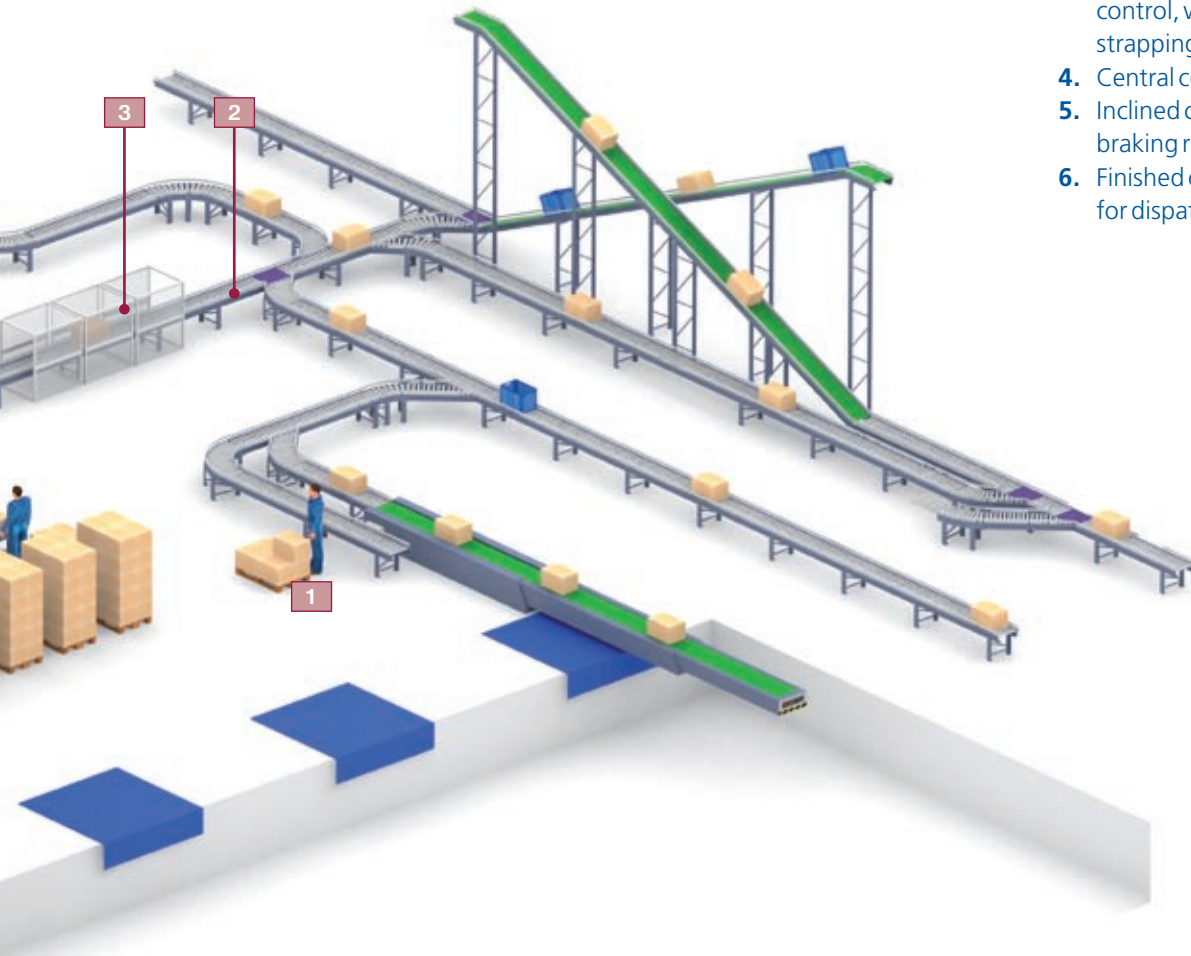

1. Injection points for the boxes on the circuit
2. Transport circuit
3. Mixed area (equipped with control, weighing, box closing, strapping equipment)
4. Central conveyor with branches
5. Inclined channel with emergency braking ramp
6. Finished orders placed on pallets for dispatch to clients

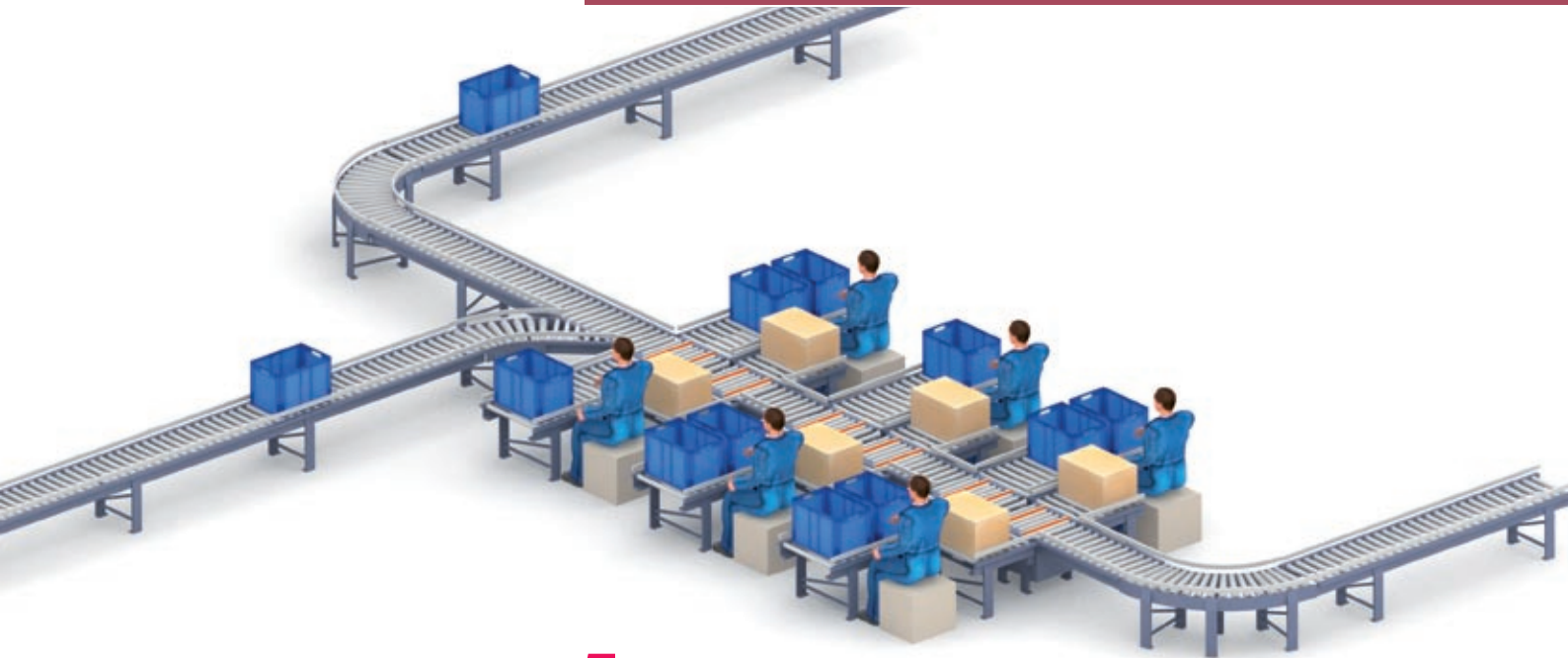

## 5

### ASSEMBLY AND VERIFICATION POSTS



The installation of automated conveyors helps to prevent dead time, transferring different components and finished products to work stations in the assembly and production areas and ensuring accurate supply and integration with other areas (warehouses, verification, dispatches, etc.).

The verification and quality control posts that are integrated into a circuit allows product to be inspected –both randomly or systematically- in order to identify errors. This is done using electronic identification devices and computer equipment and software, and boxes in which some defect has been detected are then reconditioned.

#### Other Applications

There are a wide range of applications for automated box conveyors in any production centre (warehouses, distribution centres, factories, etc.). This is why it is necessary to follow the different criteria employed in the previous examples.

Thanks to their long years of experience in the sector, the Mecalux technical teams can provide you with consultancy services to resolve your specific needs.

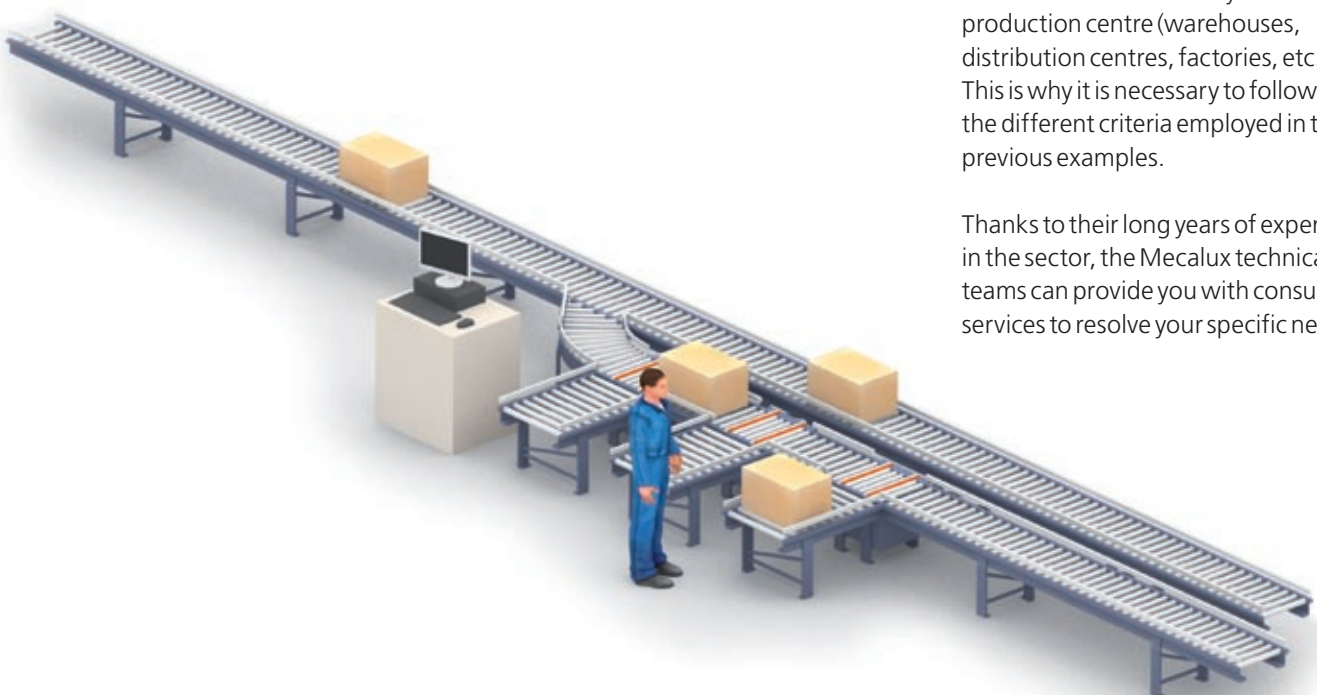



## NO-PRESSURE ROLLER ACCUMULATOR CONVEYOR

Can transfer boxes in a straight line without them coming into contact, and can also perform accumulation functions.

Their robust design guarantees their reliability in all work situations.

In all Mecalux conveyor models, the environmental conditions that are described in the technical data tables belong to the standard model. However, they can be extended with the installation of suitable protective devices.



### Technical Data / No-Pressure Roller Accumulator Conveyor

Max. load unit weight	100 kg
Max. width of exterior conveyor	947 mm
Max. useful width for box	800 mm
Min. conveyor length	525 mm
Max. conveyor length	3,150 mm
Min. box length (lengthwise direction)	150 mm
Max. box length (lengthwise direction)	800 mm
Standard transport heights	570/750 mm
Variable transport height	370-3,000 mm
Standard speeds	25/45/60 m/min
Maximum inclination	0°
Environmental conditions	Maximum humidity: 70% Ambient temperature: 0°C and 40°C









## CURVED ROLLER ACCUMULATION CONVEYOR

When the layout of your warehouse makes it impossible to employ straight lines, due to any type of architectural or structural obstacle, curved transport components are extremely useful.

They permit the transfer of boxes, as well as being able to change the transport direction by different angles, with standard curve configurations of 45°, 90° and 180°. These conveyors can be attached and integrated with each other.

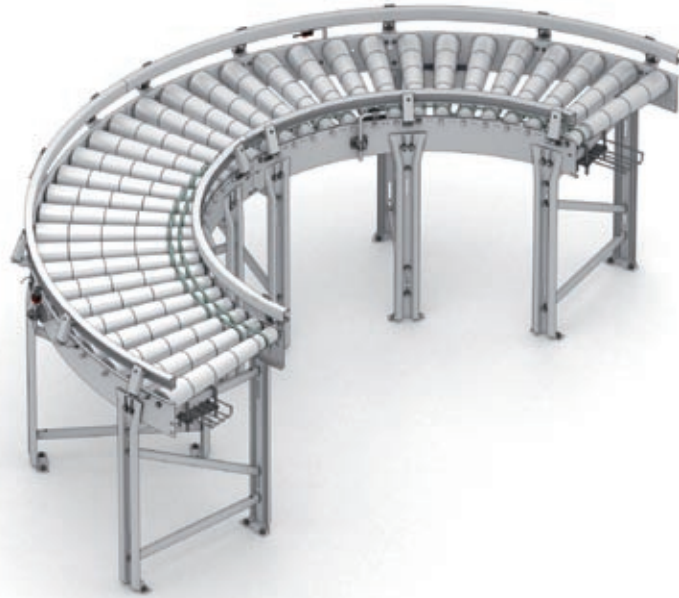

### Technical Data / Curved Roller Accumulation Conveyor

Max. load unit weight	100 kg
Curve angle	45/90/180°
Accumulation zone	0/1/2
Max. width of exterior conveyor	711 mm
Max. useful width for box	600 mm
Min. box length (lengthwise direction)	250 mm
Max. box length (lengthwise direction)	800 mm
Standard transport heights	570/750 mm
Variable transport height	370-3,000 mm
Speeds	25/45/60 m/min
Maximum inclination	0°
Environmental conditions	Maximum humidity: 70% Ambient temperature: 0°C and 40°C





## CONTINUOUS ACTIVATED ROLLER CONVEYOR

This system is used to transfer boxes in a straight line when a constant flow of load units is required and where boxes can be accumulated by contact with each other. This system is also suitable for transporting loads along long sections and even with slight inclinations.

The continuous roller conveyor, unlike the accumulation conveyor (LRA), operates with a single motor that provides enough traction to maintain a continuous flow of loads. This conveyor covers large distances and can reach high flow rates.

### Technical Data / Continuous Activated Roller Conveyor

Max. weight per linear metre	100 kg/m
Max. width of exterior conveyor	747 mm
Max. useful width for box	600 mm
Min. conveyor length	2,025 mm
Max. conveyor length	15,000 mm
Min. box length (lengthwise direction)	150 mm
Max. box length (lengthwise direction)	800 mm
Standard transport heights	570/750 mm
Variable transport height	370-3,000 mm
Standard speeds	25/45/60 m/min
Maximum inclination	6°
Environmental conditions	Maximum humidity: 70% Ambient temperature: 0° C and 40° C



## FREE ROLLER CONVEYOR

This system is equipped with rollers with no motor, suitable for use in gravity accumulation, in dispatch areas and at work stations.



### Technical Data / Free Roller Conveyor

Max. load unit weight	100 kg
Max. width of exterior conveyor	747 mm
Max. useful width for box	600 mm
Min. conveyor length	450 mm
Max. conveyor length	3,150 mm
Min box length (lengthwise direction)	150 mm
Max. box length (lengthwise direction)	800 mm
Standard transport heights	570/750 mm
Variable transport height	370-3,000 mm
Maximum inclination	Variable
Environmental conditions	Maximum humidity: 70% Ambient temperature: 0°C and 40°C

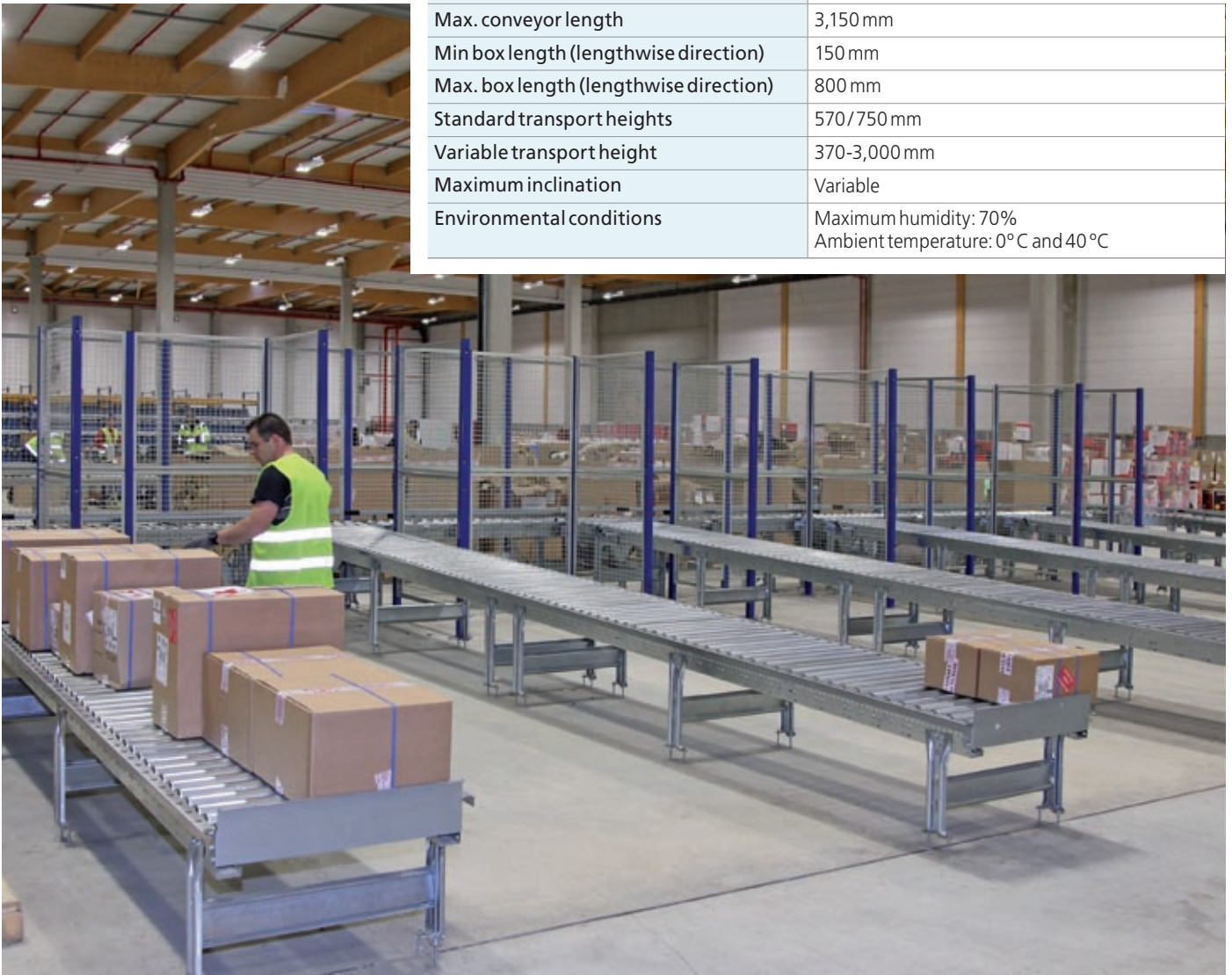

## MIXED TRANSFER ROLLER & BELT CONVEYOR

Presents a high yield solution for problems with crossovers and allows highly complex adaptations to the design of installations.

This system for a 90° change in direction is combined with a fixed roller conveyor and a belt lift conveyor with an orthogonal layout. It also has a collapsible limit buffer that ensures that the box is correctly positioned during transfer.

Depending on the length to cover in the transport direction with belts, the most appropriate option may be a symmetric system (longer transport length required) or an asymmetrical system (shorter transport length required).



### Technical Data / Mixed Transfer Roller & Belt Conveyor

Max. load unit weight	100 kg
Max. width of exterior conveyor	723 mm
Max. box width with rollers	400 mm
Conveyor length	708 mm
Min. box length (roller direction)	250 mm
Max. box length (roller direction)	600 mm
Standard transport heights	570/750 mm
Variable transport height	500-3,000 mm
Speeds	25-45 m/min
Maximum inclination	0°
Environmental conditions	Maximum humidity: 70% Ambient temperature: 0°C and 40°C





## BOOSTER CONVEYOR

The purpose of this conveyor is to change the direction of the load within an installation at any given moment, to facilitate the passage of goods and optimise cycle time.



### Technical Data / Booster Conveyor

Max. load unit weight	50 kg
Max. width of exterior conveyor	667 mm
Max useful width for box	600 mm
Min conveyor length	675 mm
Max conveyor length	1,050 mm
Min box length (lengthwise direction)	150 mm
Max box length (lengthwise direction)	800 mm
Standard transport heights	570/750 mm
Variable transport height	370-3,000 mm
Standard speeds	25/45/60 m/min.
Maximum inclination	0°
Environmental conditions	Maximum humidity: 70% Ambient temperature: 0° C and 40° C

## LAUNCHER ROLLER CONVEYOR

This system is employed to execute a 90° change in direction in which the load is launched orthogonally at a junction with the aid of a motorised roller.

One of its advantages is the quick return on investment without having to sacrifice ordered and profitable operations.

This component provides great flexibility for reception and dispatch functions.



### Technical data / Launcher Roller Conveyor

Max. load unit weight	50 kg
Conveyor width	747 mm
Max. useful width for box	600 mm
Conveyor length	900 mm
Box length	400 mm
Standard transport heights	570/750 mm
Variable transport height	370-3,000 mm
Standard transport speed	60 m/min
Maximum inclination	0°
Environmental conditions	Maximum humidity: 70% Ambient temperature: 0° C and 40° C



## OBLIQUE BOX TRANSFER

At installations where there is a large number of transport units moving throughout the system, entry and exit branches should be installed, as well as inductions to high speed lines. This is where this group of components is particularly useful, facilitating operations to change direction at high speeds.



### Technical Data / Oblique Box Transfer

Application	Oblique transfer
Max. load unit weight	50 kg
Conveyor length	1,500 mm
Width of outer conveyor	467/667 mm
Standard conveyor height	570/750 mm
Non-standard conveyor height (min - max)	370-3,000 mm
Standard speeds	25/45/60 mm
Environmental conditions	Maximum humidity: 70% Ambient temperature: between 0°C and 40°C



## CONTINUOUS BELT CONVEYOR

Useful for moving boxes in a straight line when a uniform flow of load units is required, maintaining a constant distance or position between them.

This system is also suitable when a transport speed is required that is greater than 60 m/min or when the surface contact between loads and rollers is insufficient.

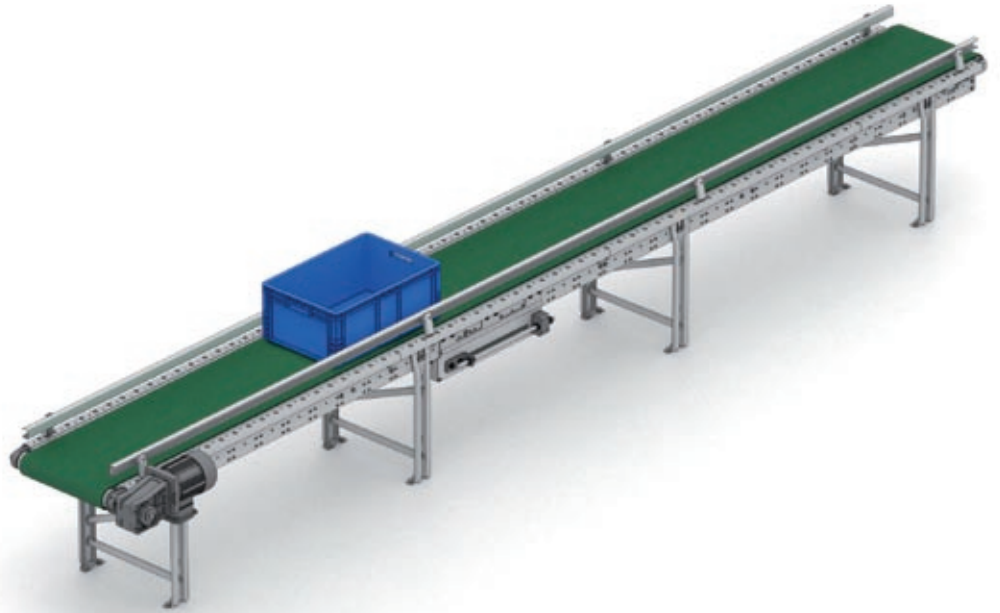

Technical Data / Continuous Belt Conveyor					
	RANGE 1		RANGE 2	RANGE 3	
	Straight	Inclined	Straight	Straight	Inclined
Max. weight per linear metre	100 kg/m				
Max. width of exterior conveyor	747 mm				
Max. useful width for box	600				
Min. conveyor length	675 mm	4,575 mm			
Max. conveyor length	4,500 mm	20,000 mm	30,000 mm		
Min. box length (lengthwise direction)	150 mm				
Max. box length (lengthwise direction)	800 mm				
Standard transport heights	570/750 mm				
Variable transport height	370-3,000 mm				
Speeds	25/45/60				
Maximum inclination	0°	12°	0°	0°	24°
Environmental conditions	Maximum humidity: 70% Ambient temperature: 0°C and 40°C				



## BRIDGE BELT CONVEYOR

A belt conveyor can be adapted to move boxes in a straight line when a flow of goods between two different levels is required.

This LPB conveyor is suitable for sections with angles of up to 24°.



### Technical Data / Bridge Belt Conveyor

	RANGE 1	RANGE 2
	Ascent	Descent
Application	Transport of boxes and containers	
Capacity (min. - max.)	0-50 kg	
Conveyor length (min. - max.)	3.800-10.000	
Width of outer conveyor	547/747 mm	
Standard conveyor height	570/750 mm	
Non-standard conveyor height (min. - max.)	370/3,000 mm	
Available inclinations	6/12/18/24°	
Standard speeds	25/45/60 mm	
Environmental conditions	Maximum humidity: 70% Ambient temperature: 0°C and 40°C	

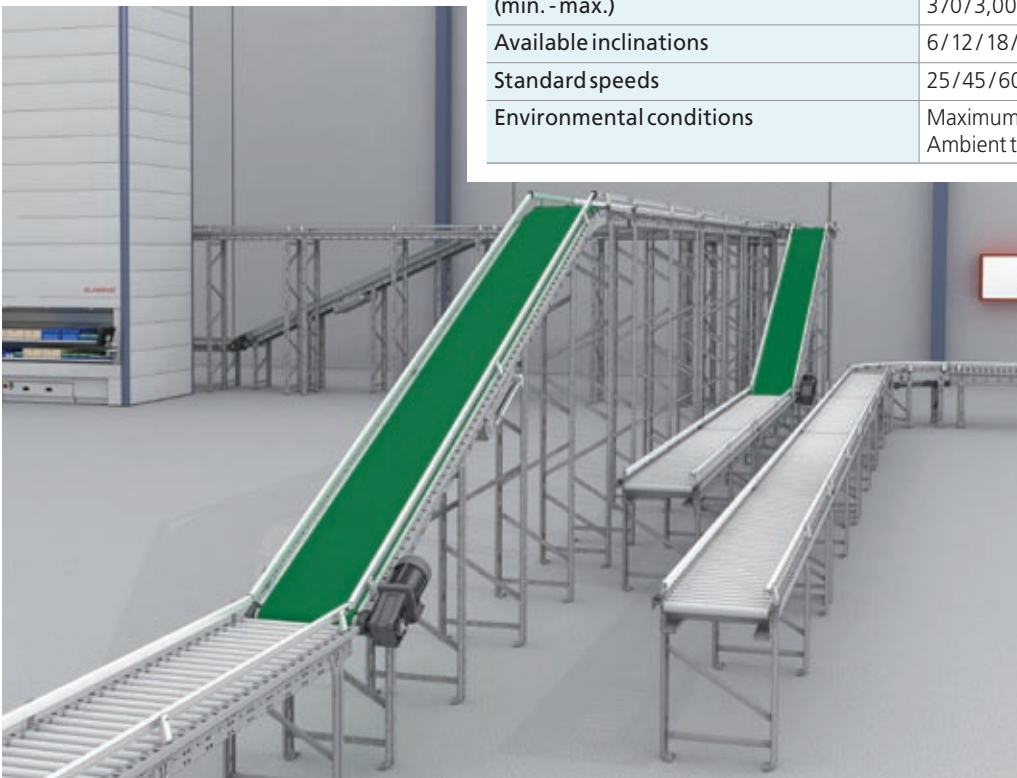

## ROLLER CONVEYOR WITH DELAY LIFTING

Specially designed for picking up and delivering load units using stacker cranes at exits and entrances to automated warehouses.

These conveyors are available in two models; the mono-load and the dual-load, and adapt perfectly to the extraction systems of standard Mecalux stacker cranes.

This system combines a roller conveyor and lifting equipment, which allows the stacker crane's extractor system access under the loads.

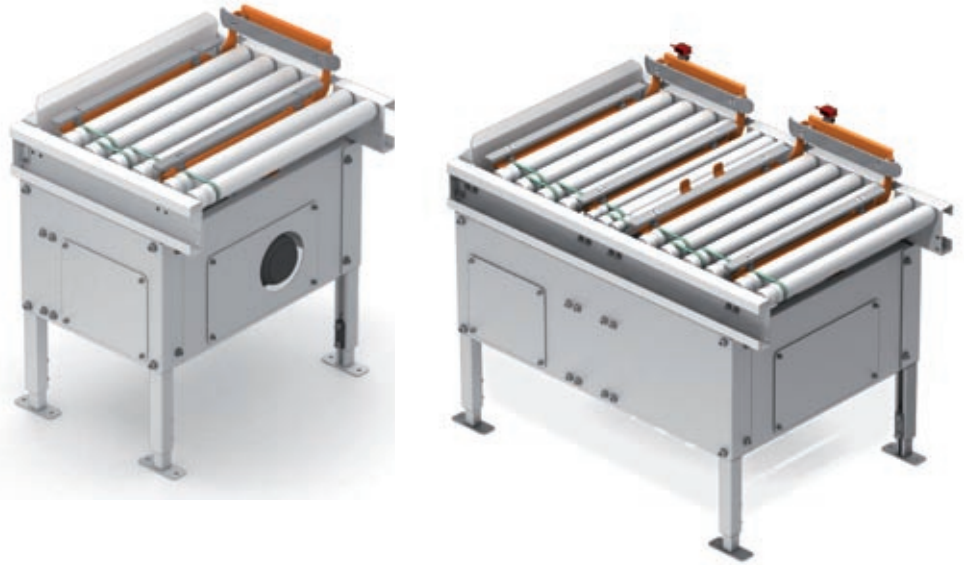

Technical Data / Roller Conveyor with Delay Lifting		
	LEE-1L	LEE-2L
Max. load unit weight	100 kg	2 x 50 kg
Max. width of exterior conveyor	747/947 mm	747/947 mm
Max. useful width for box	600/800 mm	600/800 mm
Conveyor length	565/765 mm	1,064/1,264 mm
Box length	400/600 mm	400/600 mm
Standard transport heights	750 mm	750 mm
Variable transport height	370-3,000 mm	370-3,000 mm
Speed	25 m/min	25 m/min
Environmental conditions	Maximum humidity: 70% Ambient temperature: 0° C and 40° C	

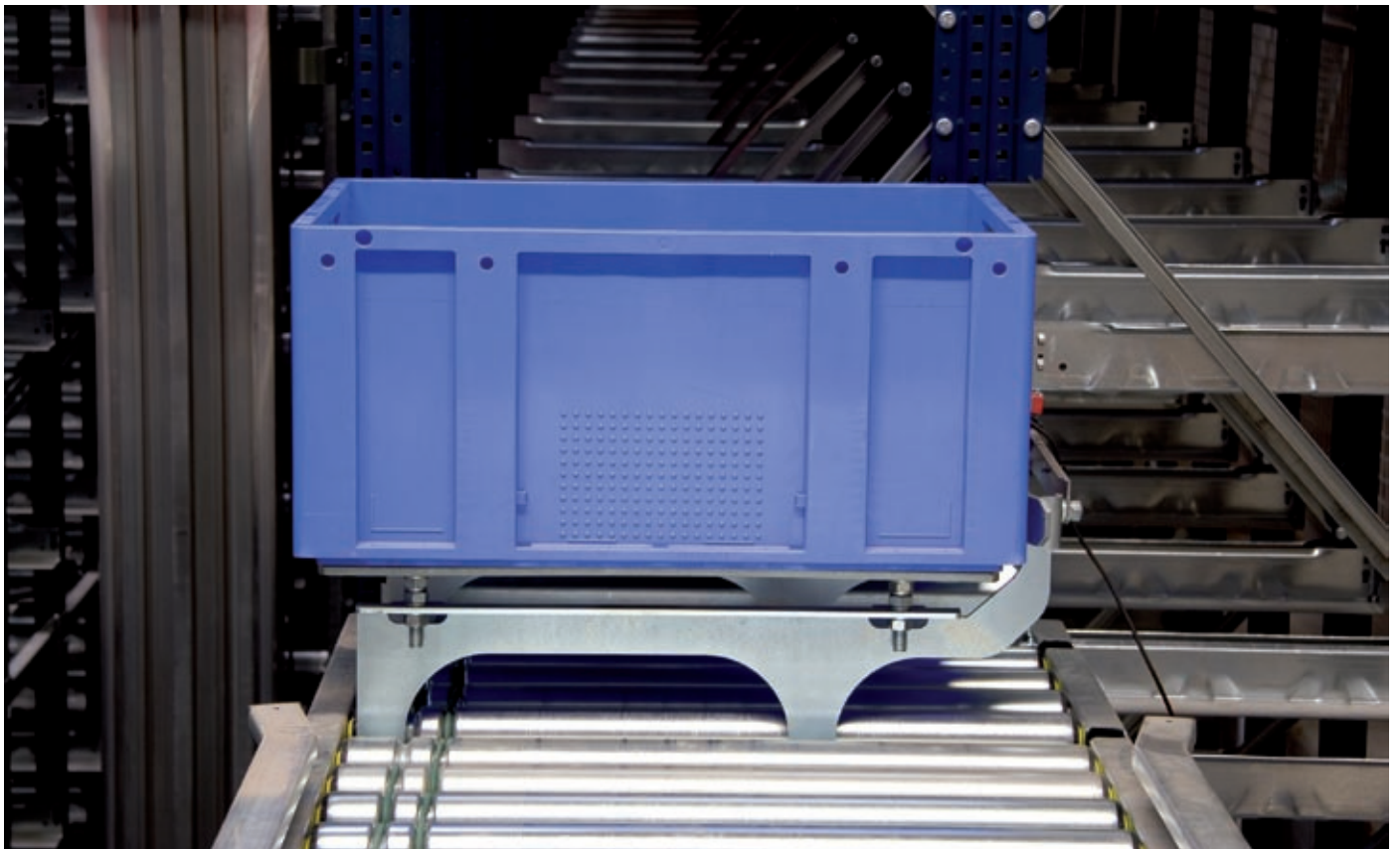

---

## DISCONTINUOUS LIFT

Allows boxes to be lifted or lowered vertically in circuits with a medium flow, connecting different plants and circulation levels.



---

## CONTINUOUS LIFT

This is a vertical lift that allows continuous lifting and lowering of goods in applications that require high flow rates.

Characterised its large capacity and ability to move loads at high speeds, thanks to its continuous lifting operation.

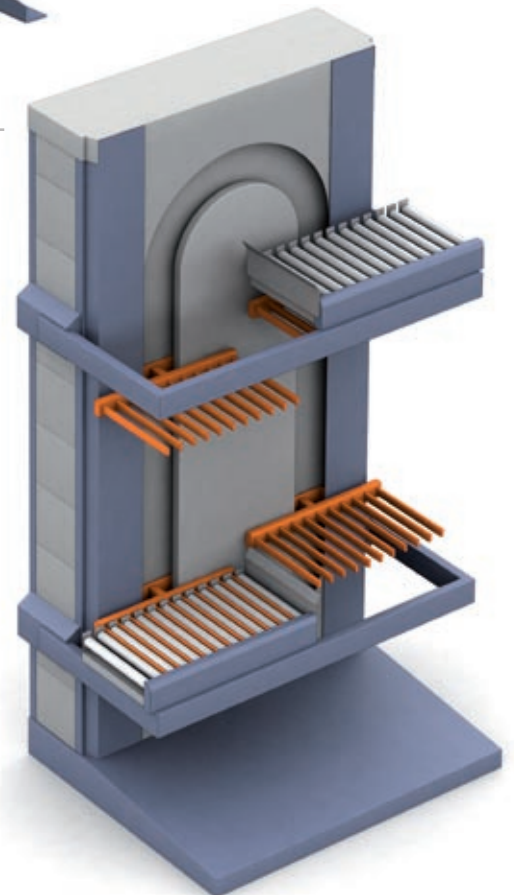

## PICKING POST

A point at which the operator interacts with the automated system. From here, handling of the components located inside the automated warehouse is carried out. Verification activities are also performed within the conveyor circuit.

Its ergonomic design ensures quality handling of loads and occupational safety.

Each component making up the picking post is safe and secure, minimising occupational risks for the operators working there.



## Detail of Lateral Picking Stations

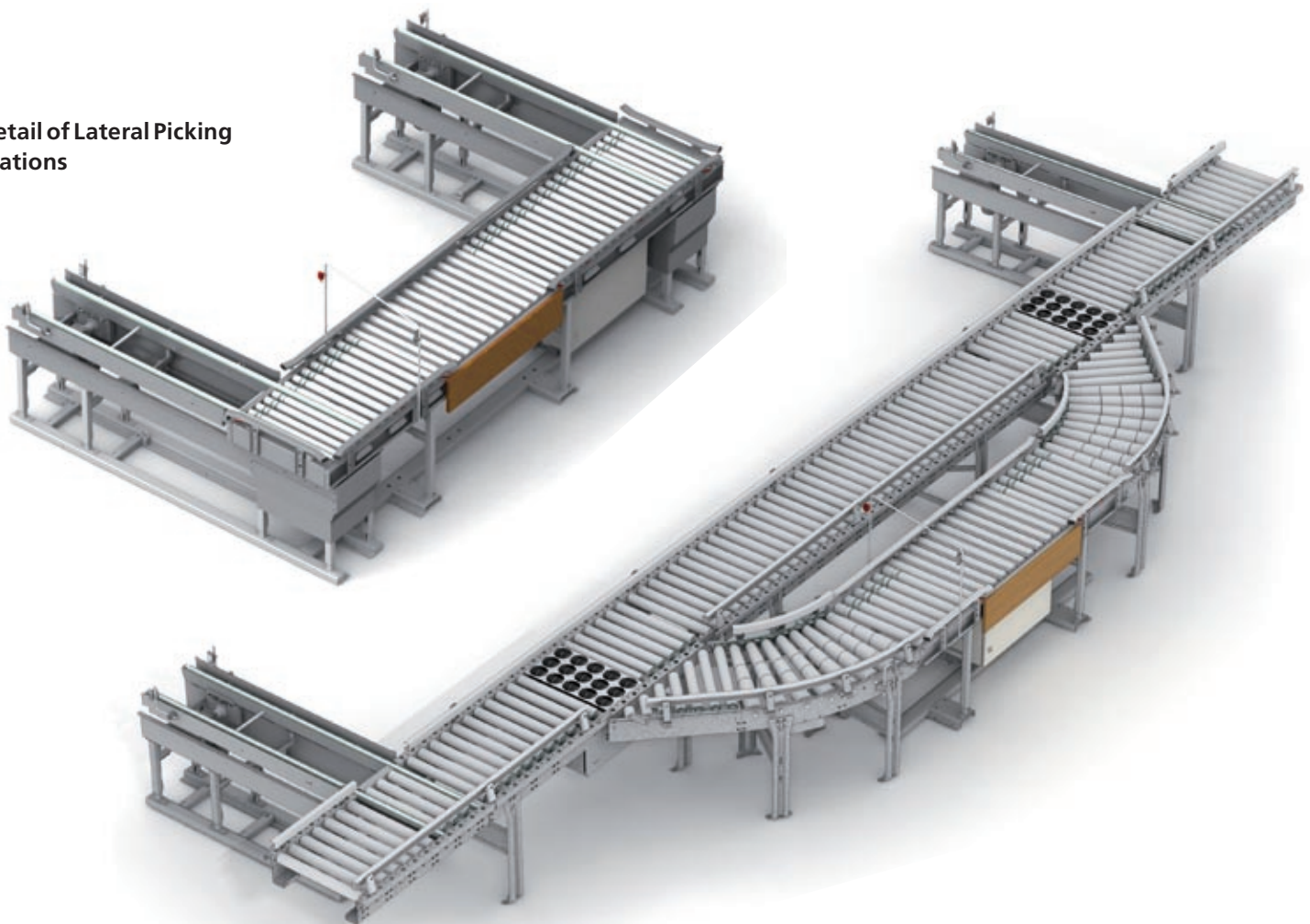

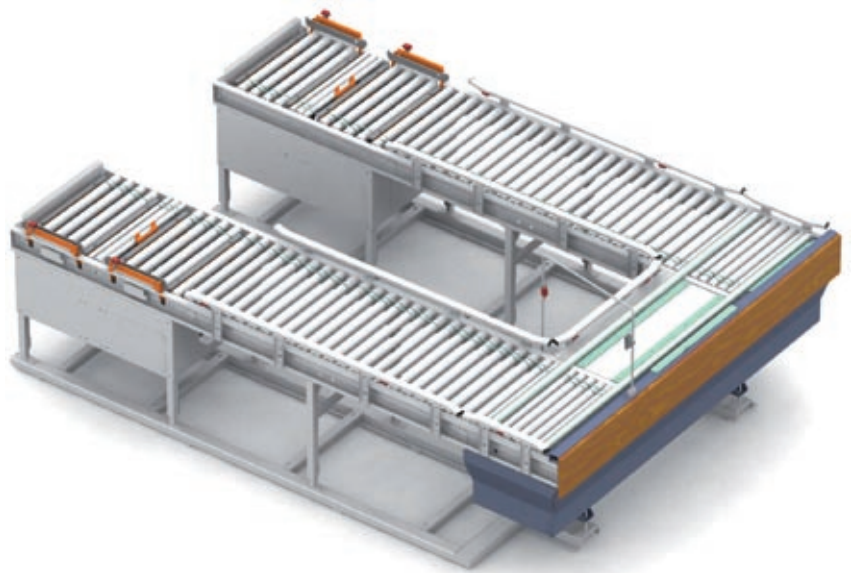

Detail of Front Picking Station with Single Head-End and Dual Extractor Pole





## SAFETY

Depending on the results of risk analysis, safety devices may need to be installed that are similar to those required at pallet installations.

In areas where they are required, metal mesh fences should be installed to prevent operators from coming into contact with the moving parts that could represent any risk. The control system stops the movement of the machines when the access doors open.

The following images show a range of different solutions and adaptations, depending on each installation's specific requirements.









## OPERATIONS LOGIC

### CONTROL

The programme that governs the control system follows logical sequences, previously parameterised, which take into account the route, the number of conveyors, the type of tables, the photocells and all other components that make up the circuit.

The control system makes the pallet or box advance, stop, turn, etc. To carry out these functions, photocells are placed on the conveyors that allow the exact location of all boxes and pallets to be monitored at all times. The control system is notified so that it can transmit the next order.

All options presented in this catalogue require this control programme. Its simplicity or complexity will depend on the size and routes of the conveyor circuits.

The control programme should not be confused with the management programme (WMS), which operates at a higher level. Normally a conveyor does not require a management programme as such, except when connected to a complex installation where it receives multiple source and destination orders. This is precisely what takes place in the headers of automated warehouses.

The control programme can be installed on a PC and use the Mecalux Galileo programme, or on a PLC. At small or straightforward plants, they tend to be installed on a PLC, whereas a PC is more convenient at more complex installations.

The great advantage of using a PC with Galileo is that it provides all information on the conveyor circuit by using the visualisation programme.

### Control and Power Components

Each conveyor has modular power boxes and signals. Their purpose is to control and power the signals on each conveyor. These boxes are connected to the main power cabinet and to the control PC or PLC.

A single power cable and another cable for signals connect the conveyors. Such a simple assembly allows modifications and expansions to be done easily and quickly. In larger installations, the conveyors are connected in series and by areas.

The central cabinet is in charge of distributing the power to each of the modular boxes, while the PC or PLC controls the installation, depending on the number of conveyors.

Area consoles and emergency push buttons complete the list of control components in an automated transport system.

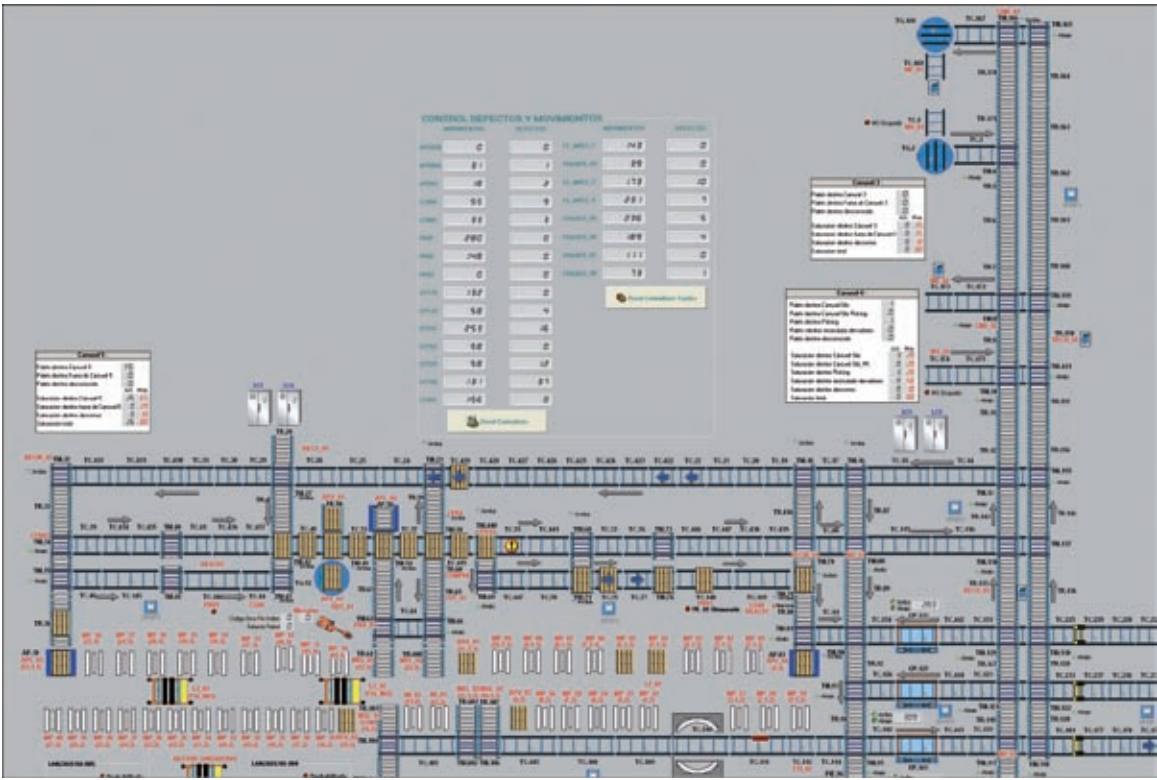
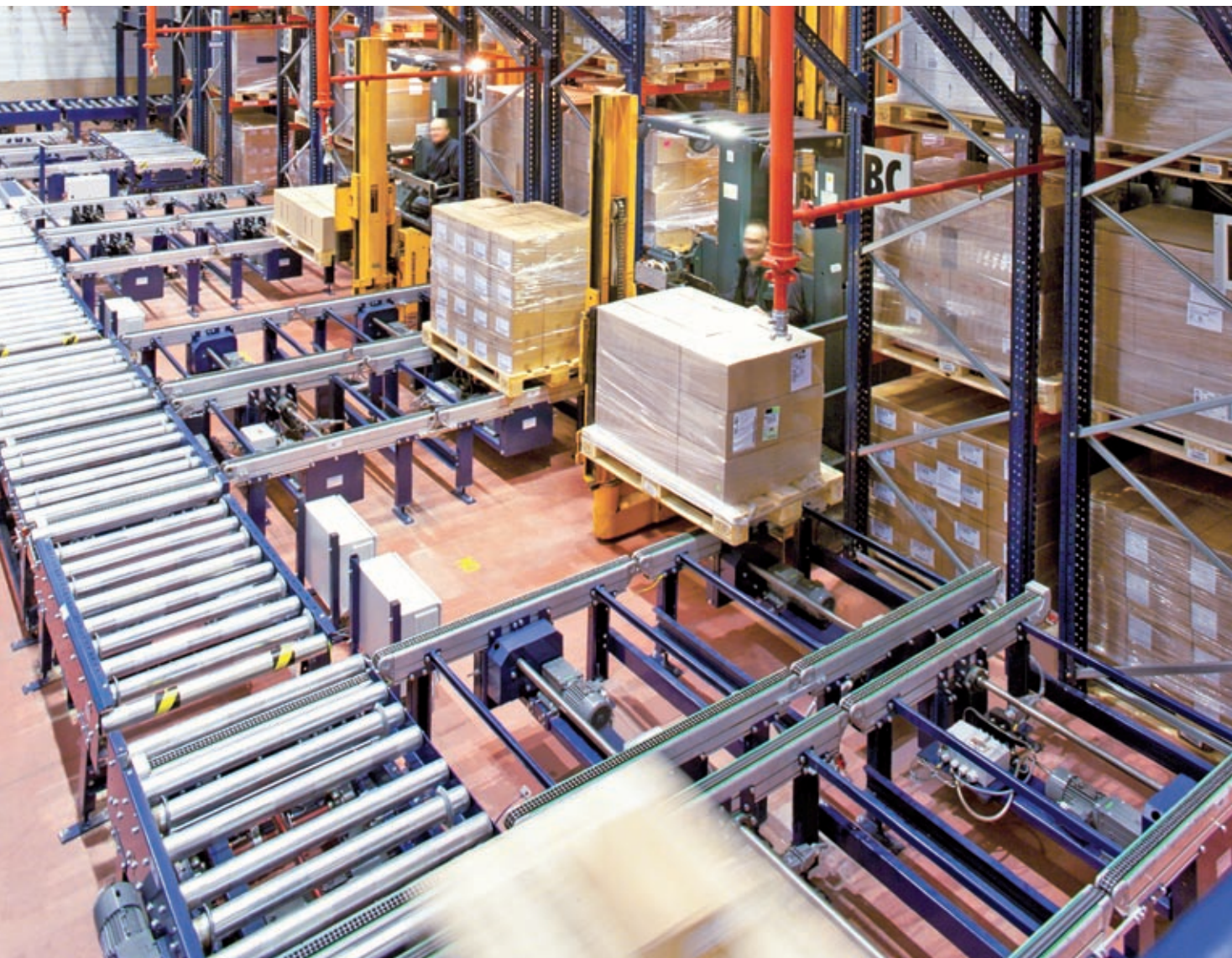



## MANAGEMENT

The most complex circuits must also have a control process; management software that directs the boxes from the starting points to the end points, using the criteria in place at each installation (destination, order, sequencing, etc.).

Easy WMS is a powerful warehouse management system that manages all typical operations in reception, warehousing, transport, order preparation and dispatch.

## General Characteristics

This software has been designed using the latest technological standards, databases with renowned international recognition and the most suitable programming languages for this type of software.

Mecalux, aware of the high level of demand with respect to the computer applications employed in the industrial arena, has created a software development centre, which is responsible for programming Easy WMS and its maintenance and updates.

## Software Functions

Easy WMS was designed under the premise of facilitating its use in all types of warehouses, taking into account their particular features and special characteristics.

When defining the main software functionalities, the practical and operative nature necessary in a high productivity setting has been taken into consideration. For this reason, a user-friendly presentation was sought for the graphic interface, custom report generation and interaction with operators.

Easy WMS lets you perform the following functions with great ease:

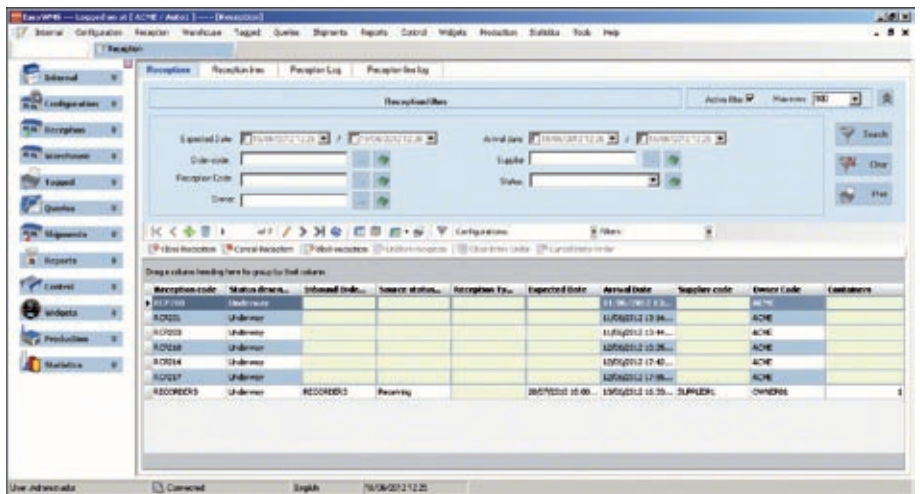

**- Entry Management:** During reception processes, EasyWMS guides users to conduct all associated tasks simply and securely. Single and multiple reference containers can be dealt with, and the necessary logistics variables can be obtained for each article (batch, expiry, serial number, weight, quality, etc.).

**- Warehousing Management:** After goods have been received, they must be stored. EasyWMS is a powerful management tool, able to define every last detail about the placement of a product within a warehouse. This process is based on rules and strategies for the location of materials, always taking into account the physical and logistic characteristics of the product in question.

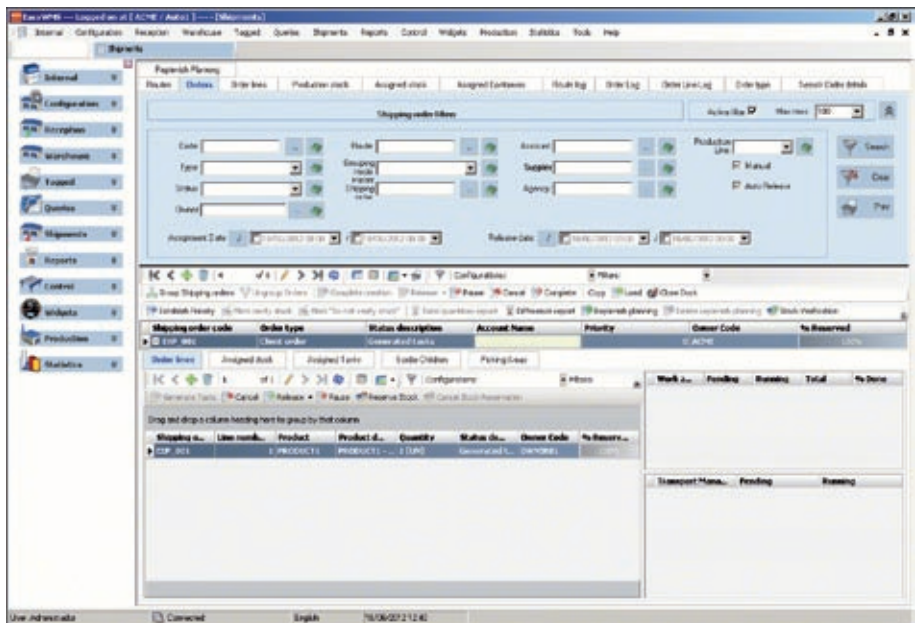

**- Exit Management:** To carry out the output of materials, Easy WMS provides a practical system to prepare orders, which uses concepts for both individual output orders and orders grouped into distribution routes. These orders can be entered manually or imported from the company's ERP.

For more productive work, several grouping modes for the output orders are also provided, as well as the possibility of sequencing their release automatically. This is all done with the aim of completing the greatest number of picking operations possible with the least number of movements of the stacking crane and from the same work station.

**- Stock Management:** Easy WMS provides total control of all warehoused stock, where you can find out information on all stock and its condition in real time. These figures can be corrected and adjusted at any time. Easy WMS also manages and handles the article master, where all main data on all stored articles can be added, deleted or changed. Specific logistics details can also be applied to products for reception, storage and dispatch management.



**- Consultation and Reporting Tools:** Users can make consultations at all times about the status of the warehouse and the components involved in the various operations (stacker cranes, conveyors, work stations, radiofrequency terminals, etc.). Common queries are in reference to entries, exits, logs and failure diagnoses. The most relevant information related to the occupation and workload at all times can be grouped on a single screen that displays this constantly updated data in both numerical and graphical form.

**- Integration:** Easy WMS allows coordinated management of several warehouses that, due to being part of the same organisation, share information and can have stock transferred between them.

Easy WMS can exchange information with the company's ERP: master files, delivery forecasts, client orders etc. can be imported, while information about completed transactions, stock variations etc. can be sent to the ERP.

For more detailed information, we recommend consulting the specific Easy WMS catalogue or requesting a meeting with a specialised technician.

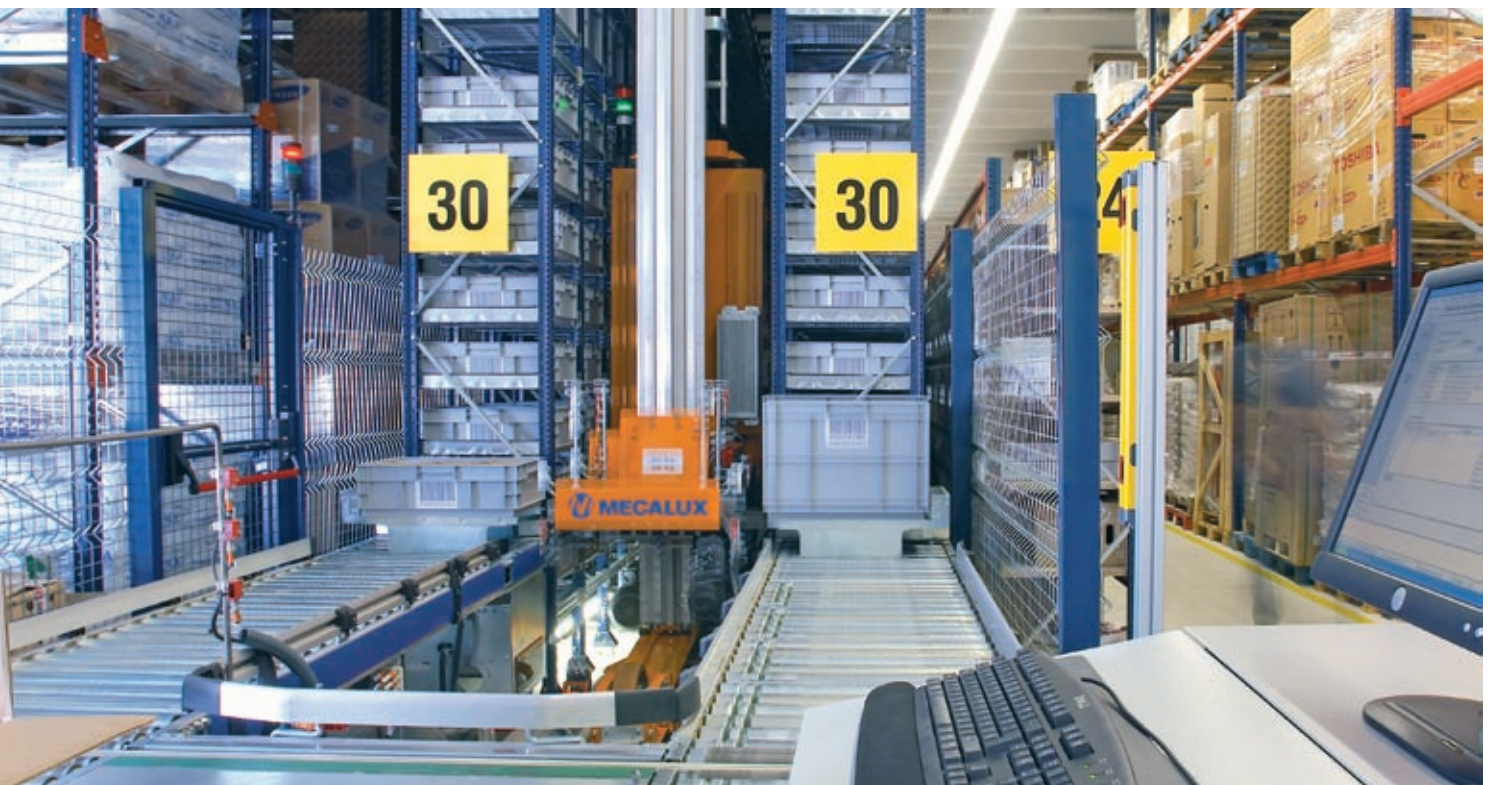



**HEAD OFFICE - SPAIN** - Silici, 1 - 08940 Cornellà de Llobregat - Barcelona  
**Tel. +34 932 616 913 – info@mecalux.com – www.mecalux.com**

**EUROPE**

**BELGIUM**

Tel. +32 2 346 90 71  
info@mecalux.be  
**www.mecalux.be**

**CZECH REPUBLIC**

Tel. +420 222 524 240  
info@mecalux.cz  
**www.mecalux.cz**

**FRANCE**

Tel. +33 01 60 11 92 92  
info@mecalux.fr  
**www.mecalux.fr**

**GERMANY**

Tel. +49 (0) 2131 40 760  
info@mecalux.de  
**www.mecalux.de**

**ITALY**

Tel. +39 02 98836601  
info@mecalux.it  
**www.mecalux.it**

**NETHERLANDS**

info@mecalux.co.nl  
**www.mecalux.co.nl**

**POLAND**

Tel. +48 32-331 69 66  
info@mecalux.pl  
**www.mecalux.pl**

**PORTUGAL**

Tel. +351 21 415 18 90  
info@mecalux.pt  
**www.mecalux.pt**

**SLOVAKIA**

Tel. + 421 220 545 117  
info@mecalux.sk  
**www.mecalux.sk**

**TURKEY**

Tel. +90 216 706 10 15  
info@mecalux.com.tr  
**www.mecalux.com.tr**

**UNITED KINGDOM**

Tel. +44 0121 3336 602  
info@mecalux.co.uk  
**www.mecalux.co.uk**

**AMERICA**

**ARGENTINA**

Tel. +54 (11) 4006-4444  
info@mecalux.com.ar  
**www.mecalux.com.ar**

**BRAZIL**

Tel. +55 11 4134-2155  
info@mecalux.com.br  
**www.mecalux.com.br**

**CHILE**

Tel. +56 (2) 2827 6000  
info@mecalux.cl  
**www.mecalux.cl**

**USA**

Tel. 1-877-632-2589  
info@interlakemecalux.com  
**www.interlakemecalux.com**

**MEXICO**

Tel. +52 (664) 647 22 00  
info@mecalux.com.mx  
**www.mecalux.com.mx**

**PERU**

Tel. +51 (1) - 422 6060  
info@mecalux.pe  
**www.mecalux.pe**

**URUGUAY**

Tel. +598 2683-8879  
info@mecalux.com.uy  
**www.mecalux.com.uy**

